

LUFFING JIB DERRICK CRANE



Specifications:

- ▶ Max jib length: 30,30 m
- ▶ Capacity at max length: 3,20 t
- ▶ Max capacity: 16,00 t

WORKS FOR YOU.™

KEY

Legenda · Zeichenerklärung · Légende · Leyenda · Legenda · Условные обозначения



Hoisting · Sollevamento · Heben · Levage · Elevación · Elevação · Подъем



Slewing · Rotazione · Schwenken · Orientation · Orientació · Giro · Поворот



Luffing · Brandeggio · Ausleger-Einziehen · Relevage · Elevación de pluma · Elevação da lança · Изменение вылета стрелы



Directive on noise level · Direttiva sul livello acustico · Richtlinie für den Schall-Leistungspegel · Directive sur le niveau acoustique · Directiva sobre el nivel acustico · Diretiva sobre nível de ruídos · Директива по уровню шума



Consult us · Consultateci · Auf Anfrage · Nous consulter · Consultarnos · Consulte-nos · Проконсультироваться с нами



Power requirements · Potenza totale richiesta · Geforderte Stromstärke · Puissance totale nécessaire · Potencia necesaria · Requisitos de energia · Требования по питанию



Power supply · Alimentazione · Stromversorgung · Alimentation · Alimentación · Fonte de alimentação · Питание



In service · In servizio · In Betrieb · En service · En servicio · Em serviço · При работе



Out of service · Fuori servizio · Außer Betrieb · Hors service · Fuera de servicio · Fora de serviço · В режиме простоя



Max. under hook height · Altezza max. sotto gancio · Höchste Hakenhöhe · Hauteur maxi. sous crochet · Maxima altura bajo gancho · Alt. máx. sob o gancho · Макс высота крюка



Jib · Braccio · Ausleger · Flèche · Pluma · Lança · Стрела



Without load, without ballast, max. jib and max. height · vuoto, senza zavorra, braccio max., altezza max. · Ohne Last und Ballast, mit Maximalausleger und Maximalhöhe · A vide, sans lest, avec flèche et hauteur maximum · Sin carga, sin lastre, con pluma y altura máxima · A Sem carga, sem lastro, lança máxima, altura máxima · Без груза, без балласта, на макс. Длине вспомогательной стрелы и макс. Высоте

CONTENTS

CDK 100-16

Indice · Inhalt · Contenu · Contenido · Sumário · Содержание

Page · Pagina · Seite · Page · Página · Página · Страница:

Load Diagram · Diagramma di portata · Lastkurven · Courbes de charges · Curvas de cargas · Diagrama de carga · Диаграмма грузоподъёмности	4
Mechanisms · Meccanismi · Antriebe · Mécanismes · Mecanismos · Механизмо · Механизм	6
Transportation · Trasporto · Transport · Transport · Transporte · Transporte · Транспортировка	7

LOAD DIAGRAM

Diagramma di portata · Lastkurven · Courbes de charges · Curvas de cargas · Diagrama de carga · Диаграмма грузоподъёмности

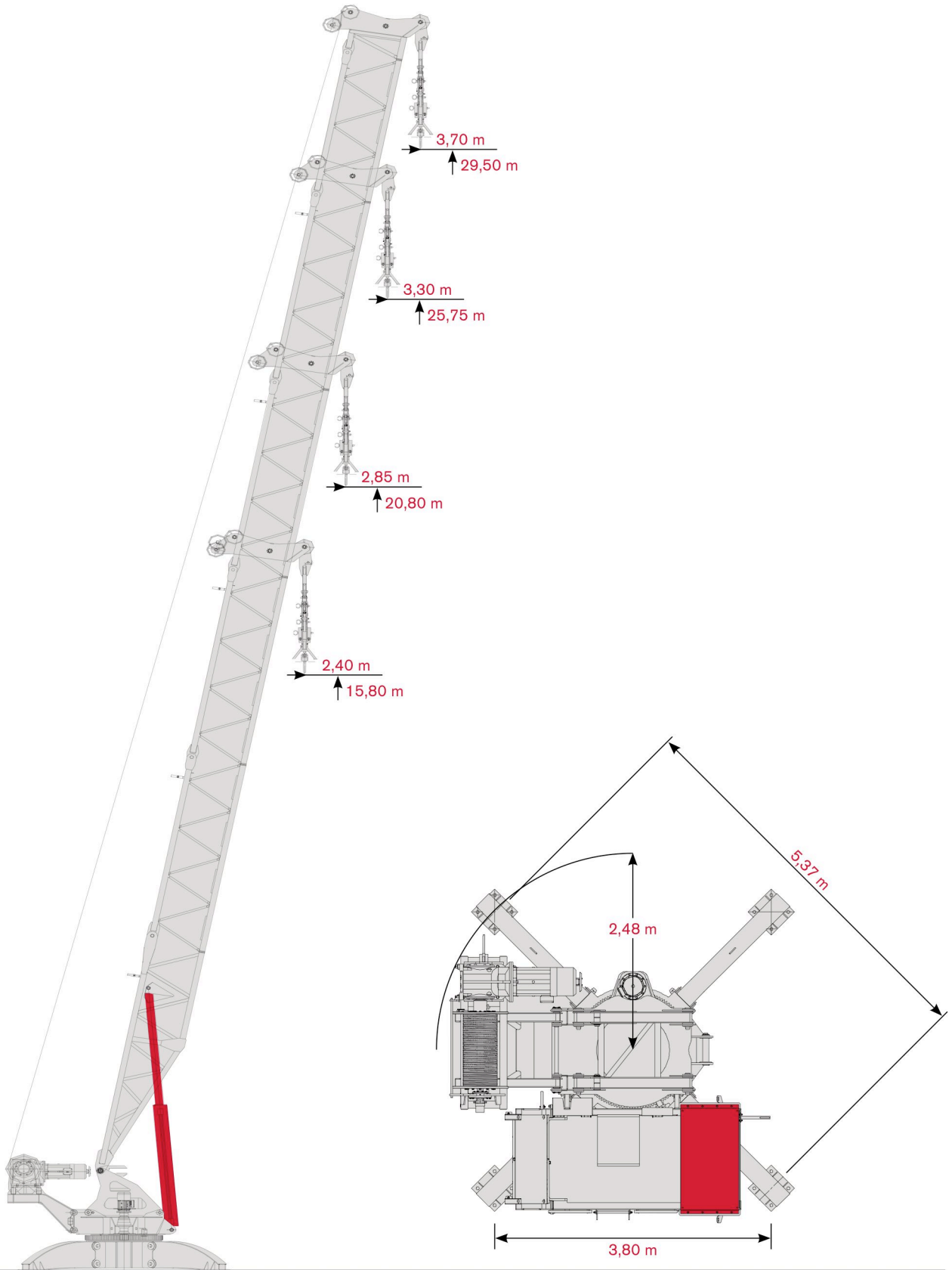

Load Diagram · Diagramma di portata · Lastkurven · Courbes de charges · Curvas de cargas · Diagrama de carga · Схема нагрузок

			6 m	9 m	12 m	15 m	16,5 m	18 m	21,5 m	24 m	26,5 m	30,3 m	
	8 t →	16,88 m	t	8,00	8,00	8,00	8,00	8,00	7,33	5,69	4,80	4,08	3,20
	12 t →	12,25 m	t	12,00	12,00	12,00	9,33	8,24	7,33	5,69	4,80	4,08	3,20
	16 t →	9,56 m	t	16,00	16,00	12,29	9,33	8,24	7,33	5,69	4,80	4,08	3,20
	8 t →	16,67 m	t	8,00	8,00	8,00	8,00	8,00	7,21	5,60	4,73	4,00	
	12 t →	12,07 m	t	12,00	12,00	12,00	9,18	8,11	7,21	5,60	4,73	4,00	
	16 t →	9,42 m	t	16,00	16,00	12,08	9,18	8,11	7,21	5,60	4,73	4,00	
	8 t →	16,27 m	t	8,00	8,00	8,00	8,00	7,85	6,99	5,40			
	12 t →	11,74 m	t	12,00	12,00	11,69	8,88	7,85	6,99	5,40			
	16 t →	9,14 m	t	16,00	16,00	11,69	8,88	7,85	6,99	5,40			
	8 t →	15,78 m	t	8,00	8,00	8,00	8,00	7,50					
	12 t →	11,33 m	t	12,00	12,00	11,21	8,53	7,50					
	16 t →	8,79 m	t	16,00	15,58	11,21	8,53	7,50					

Jib Configurations · Configurazioni braccio · Auslegerkonfigurationen · Configurations de la flèche · Configuraciones de pluma · Configurações da Lança · Конфигурация стрелы

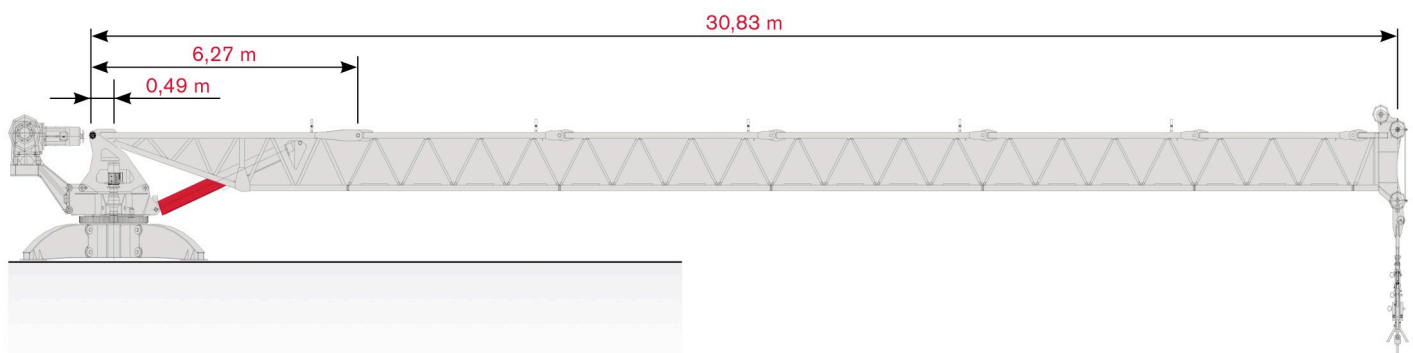
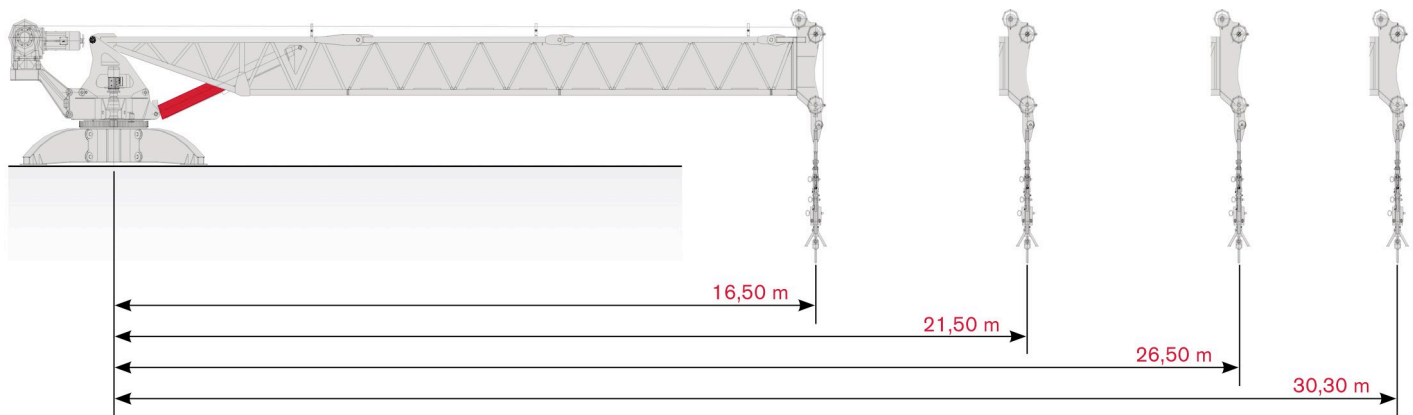

MECHANISMS

Meccanismi · Antriebe · Mécanismes · Mecanismos · Mecanismo · Механизм

Power supply · Alimentazione · Stromversorgung · Alimentation · Suministro eléctrico · Requisitos de energia · Требования по питанию

				
	35 AFC 80	87 kVA*	400V - 50Hz / 460V - 60 Hz	2000/14/CE modificata

* Average consumption · Consumo medio · Durchschnittsverbrauch · Consommation moyenne · Consumo medio · Consumo médio · Среднее потребление

Hoisting · Sollevamento · Heben · Levage · Elevación · Elevação · Подъем

			t	m/min	kW	
	35 AFC 80		8	0 → 23	37	850 m
			6	0 → 28		
			2	0 → 59		
			12	0 → 14		
			9	0 → 18		
			3	0 → 39		
			16	0 → 12		
			12	0 → 14		

Additional Specifications · Altre movimentazioni · Weitere Leistungsdaten · Spécifications additionnelles · Otras prestaciones · Especificações adicionais · Дополнительные спецификации









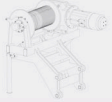

			
	LHY 140	2,5 min	30 kW
	SFC 1-65	0 → 0,75 r.p.m.	1 x 10 kW

TRANSPORTATION

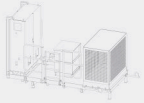
CDK 100-16

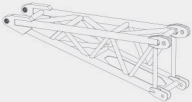



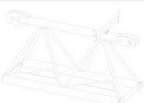
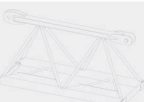

Trasporto · Transport · Transport · Transporte · Transporte · Транспортировка

Packing list

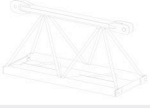
CDK100-16	DESCRIPTION · DESCRIZIONE · BESCHREIBUNG · DESCRIPTION · DESCRIPCIÓN · DESCRIÇÃO · ОПИСАНИЕ	LENGTH · LUNGHEZZA · LÄNGE · LONGUEUR · LONGITUD · COMPRIMENTO · ДЛИНА	WIDTH · LARGHEZZA · BREITE · LARGEUR · ANCHURA · LARGURA · ШИРИНА	HEIGHT · ALTEZZA · HÖHE · HAUTEUR · ALTURA · ALTURA · ВЫСОТА	QUANTITY · QUANTITÀ · MENGE · QUANTITÉ · CANTIDAD · QUANTIDADE · КОЛИЧЕСТВО	WEIGHT · PESO · GEWICHT · POIDS · PESO · PESO · ВЕС
	BASE SUPPORT	2,07 m	0,45 m	0,77 m	4	385 kg
	SLEWING UNIT	2,23 m	2,16 m	2,00 m	1	3352 kg
	COUNTER JIB UNIT	1,82 m	2,41 m	2,08 m	1	2584 kg
	JIB CONNECTION FRAME	1,66 m	1,06 m	1,27 m	1	623,7 kg
	PLATFORM	3,23 m	1,81 m	2,06 m	1	2060 kg
	LUFFING RAMS	3,88 m	0,42 m	0,44 m	1	1370 kg
	JIB SECTION 01	3,89 m	1,06 m	1,30 m	1	1135 kg
	JIB SECTION 02	3,00 m	1,08 m	1,32 m	1	1233 kg
	JIB SECTION 03	2,64 m	1,02 m	1,27 m	1	425 kg
	JIB SECTION 04	2,77 m	1,02 m	1,29 m	1	403,5 kg
	JIB SECTION 05	2,76 m	1,02 m	1,29 m	1	398 kg
	JIB SECTION 06	2,74 m	1,02 m	1,28 m	1	339,5 kg
	JIB SECTION 07	2,71 m	1,02 m	1,28 m	1	303 kg

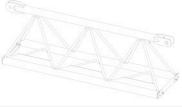
TRANSPORTATION

Trasporto · Transport · Transport · Transporte · Transporte · Транспортировка

CDK100-16	DESCRIPTION · DESCRIZIONE · BESCHREIBUNG · DESCRIPTION · DESCRIPCIÓN · DESCRIÇÃO · ОПИСАНИЕ	LENGTH · LUNGHEZZA · LÄNGE · LONGUEUR · LONGITUD · COMPRIMENTO · ДЛИНА	WIDTH · LARGHEZZA · BREITE · LARGEUR · ANCHURA · LARGURA · ШИРИНА	HEIGHT · ALTEZZA · HÖHE · HAUTEUR · ALTURA · ALTURA · ВЫСОТА	QUANTITY · QUANTITÀ · MENGE · QUANTITÉ · CANTIDAD · QUANTIDADE · КОЛИЧЕСТВО	WEIGHT · PESO · GEWICHT · POIDS · PESO · PESO · ВЕС
	JIB SECTION 08	2,71 m	1,02 m	1,28 m	1	299,5 kg
	JIB SECTION 09	2,71 m	1,02 m	1,28 m	1	244 kg
	JIB SECTION 10	2,82 m	1,02 m	1,28 m	1	244,5 kg
	JIB SECTION 11	3,97 m	1,02 m	1,28 m	1	320,5 kg
	JIB END	1,40 m	1,02 m	2,26 m	1	524 kg
	SWINGING SUPPORT	1,20 m	0,32 m	1,55 m	1	164 kg
	HOIST BLOCK UNIT	1,20 m	0,12 m	1,46 m	1	537,4 kg