

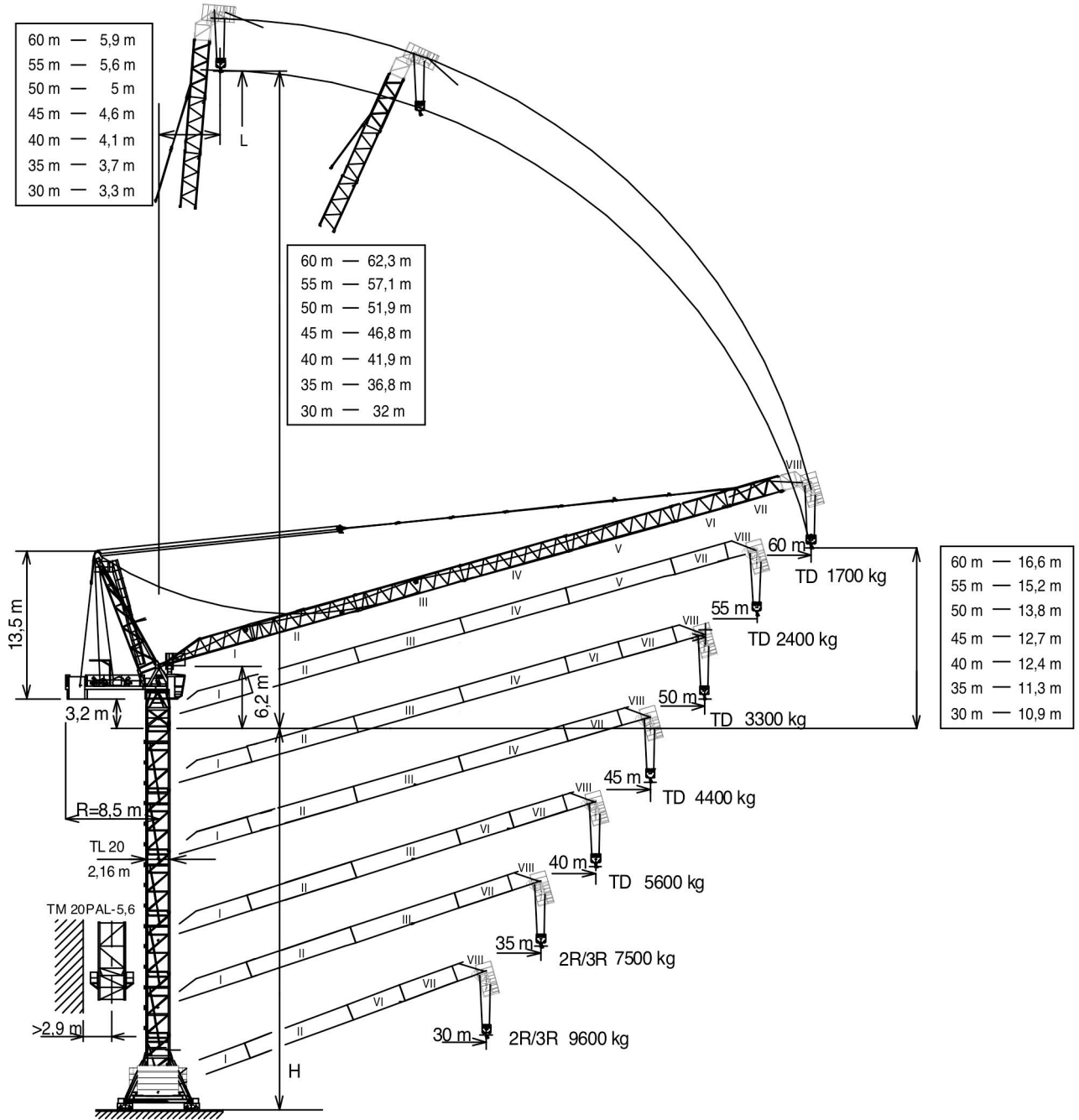

EN 14439
C25

UNE-EN-ISO 9001



Máxima altura de torre sin arriostrar (m). Maximum tower height without fastening (m). Hauteur maximale de tour sans ancrage (m). Максимальная высота башни без крепления (м). Desteksiz maksimum kule yüksekliği (m) أقصى ارتفاع للبرج بدون ربط (م)	H	*Tramo pluma I / Jib section I ----- 207.40.000 *Tramo pluma II / Jib section II --- 207.41.000 *Tramo pluma III / Jib section III-- 207.42.000 *Tramo pluma IV / Jib section IV-- 207.43.000 *Tramo pluma V / Jib section V--- 207.44.500 *Tramo pluma VI / Jib section VI- 207.44.000 *Tramo pluma VII / Jib section VII 207.45.000 **Punta pluma VIII/ Jib end VIII--- 207.46.000 BLI 6-20-5,6 ----- 211.20.500 BSI 8-20-5,6 ----- 211.20.000 ABH 100 ----- 201.23.000	AL 20----- 153.21.800 AS 20 ----- 160.21.010 ASR 20 ----- 160.21.200 TL 20 ----- 153.31.000 TL 20-5,6 ----- 204.31.400 TS 20-5,6 ----- 204.31.200 TS 20-5,6A ----- 204.31.500 TSR 20-5,6 ----- 204.31.000 TSR 20-5,6A ----- 204.31.300 TM 20PAL-5,6----- 166.35.500
* Tramo pluma / Jib section / Tronçon de flèche / Секция стрелы / Bom bölümü / أجزاء الذراع	** Punta de pluma / Jib end / Pointe de flèche / Конец стрелы / Bom ucu / مقدمة الذراع		

Fecha / Date: 01/09/2017



Reservado el derecho a modificaciones sin previo aviso. Declinamos toda responsabilidad derivada de la información proporcionada / Subject to modification, without previous warning. This information is supplied without liability / L'entreprise se réserve le droit de procéder à des modifications sans préavis. Nous déclinons toute responsabilité quant aux informations fournies / Мы оставляем за собой право на внесение изменений без предварительного уведомления. Мы снимаем с себя любую ответственность в отношении предоставленной информации / Önceden bildirilmeksizin değiştirilme hakkı saklıdır. Verilen bilgiler için hiçbir sorumluluk kabul etmemekteyiz
 حقوق التغيير محفوظة دون إشعار مسبق. دون أدنى مسؤولية عن المعلومات المقدمة

FEM 1005 - C25

(H) TRASLACIÓN / TRAVELLING /

TRASLATION / ПЕРЕМЕЩЕНИЕ / RAY YÜRÜYÜŞLÜ / متحركة

(H) ESTACIONARIA / STATIONARY /

STATIONAIRE / СТАЦИОНАРНОЕ СОСТОЯНИЕ / SABIT / ثابتة

Travelling Tower Configurations:

- Configuration 1 (6m diameter):** Height 50.0m. Table:

H(m)	□	□	
30	50,0	7	1
35	46,1	7	-
40	46,1	7	-
45	40,5	6	-
50	40,5	6	-
55	38,8	5	1
60	34,9	5	-
- Configuration 2 (6m diameter):** Height 45.1m. Table:

H(m)	□	□	
30	45,1	8	-
35	45,1	8	-
40	43,4	7	1
45	39,5	7	-
50	39,5	7	-
55	37,8	6	1
60	33,9	6	-
- Configuration 3 (6m diameter):** Height 49.8m. Table:

H(m)	□	□	
30	49,8	7	1
35	45,9	7	-
40	45,9	7	-
45	40,3	6	-
50	40,3	6	-
55	38,8	5	1
60	34,7	5	-
- Configuration 4 (8m diameter):** Height 57.3m. Table:

H(m)	□	□	□		
30	57,3	1	1	7	-
35	57,3	1	1	7	-
40	55,6	1	1	6	1
45	51,8	1	1	6	-
50	51,8	1	1	6	-
55	46,2	1	1	5	-
60	46,2	1	1	5	-
- Configuration 5 (8m diameter):** Height 54.6m. Table:

H(m)	□	□	□		
30	54,6	1	1	7	1
35	50,7	1	1	7	-
40	50,7	1	1	7	-
45	49,0	1	1	6	1
50	45,1	1	1	6	-
55	45,1	1	1	6	-
60	39,5	1	1	5	-
- Configuration 6 (8m diameter):** Height 57.2m. Table:

H(m)	□	□	□		
30	57,2	1	1	7	-
35	57,2	1	1	7	-
40	55,5	1	1	6	1
45	51,6	1	1	6	-
50	51,6	1	1	6	-
55	46,0	1	1	5	-
60	46,0	1	1	5	-

Legend:

- TL 20
- TL 20-5,6
- ▨ TS 20-5,6A
- ⊠ TS 20-5,6
- ▨ TSR 20-5,6A
- ⊠ TSR 20-5,6

TREPADO / CLIMBING / TÉLESCOPAGE / ЛЕСТНИЦА / TIRMANMA / التسلق

Internal Climbing System Details:

- Height: $H < 250\text{ m}$
- Horizontal distance: 2,16m
- Vertical distance: 3xTL 20-5,6
- Other components: TS 20-5,6A, 2xTS 20-5,6, TS 20-5,6T
- Dimensions: 2,8x2,45

Maximum Height Formula:
 $h_{\text{max}} = \text{TS 20-5,6T} + 2 \times \text{TS 20-5,6} + \text{TS 20-5,6A} + 3 \times \text{TL 20-5,6}$

h (m)	39,2
D (m)	15,6 - 19
P (KN)	1025 905
Rmax (KN)	247 498

TS20-5,6T: 160.32.600

Legend:

- ▶ En servicio / In service / En service / В работе / Devrede / الخدمة
- Fuera de servicio / Out of service / Hors service / В покое / Devre dışı / خارج الخدمة

Information: Trepado interno / Internal climbing. / Téléscopage intérieur / Внутренняя лестница / Bina içi tirmanma / التسلق الداخلي



- ▶ Viento fuera de servicio / Out of service wind / Vitesse du vent hors service / Ветровая нагрузка в покое / Rüzgar devre dışı / الريح خارج الخدمة
- ▶ Consultar / Consult / Nous consulter / Консультируйтесь / Danışınız / الرجوع إلى
- ▶ En servicio / In service / En service / В работе / Devrede / الخدمة
- Fuera de servicio / Out of service / Hors service / В покое / Devre dışı / خارج الخدمة











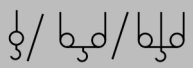





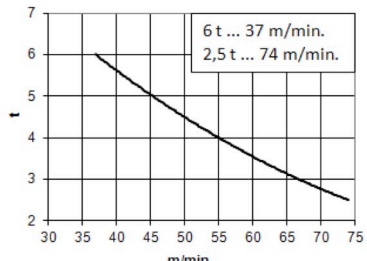
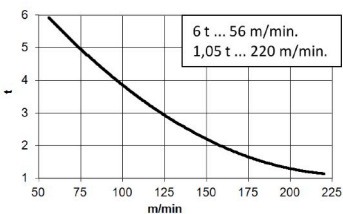
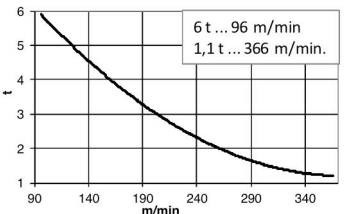

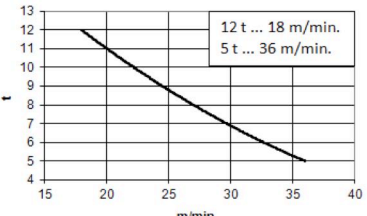
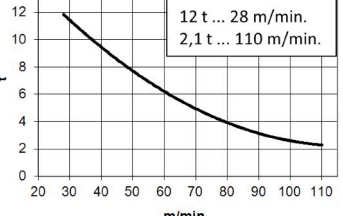
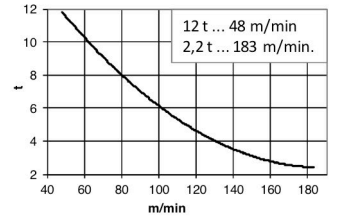
Fecha / Date: 01/09/2017

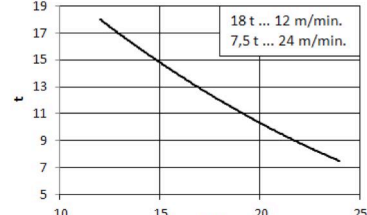
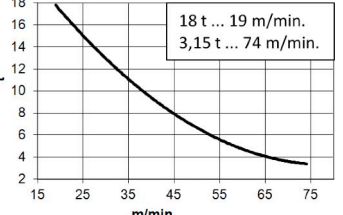
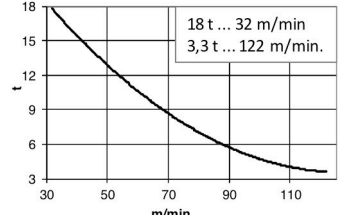
FEM 1005 - C25

Reservado el derecho a modificaciones sin previo aviso. Declinamos toda responsabilidad derivada de la información proporcionada / Subject to modification, without previous warning. This information is supplied without liability / L'entreprise se réserve le droit de procéder à des modifications sans préavis. Nous déclinons toute responsabilité quant aux informations fournies / Мы оставляем за собой право на внесение изменений без предварительного уведомления. Мы снимаем с себя любую ответственность в отношении предоставленной информации / Önceden bildirilmeksizin değiştirilme hakkı saklıdır. Verilen bilgiler için hiçbir sorumluluk kabul etmemekteyiz / حقوق التغيير محفوظة دون إشعار مسبق. دون أدنى مسؤولية عن المعلومات المقدمة

 TD [t]		Cargas máximas / Maximum loads / Charges maximales / Максимальные нагрузки / Maksimum yük / أقصى حمولة TD – 6t							
 [m]	TD 6t @ (m)	Alcance del gancho [m] / Hook reach [m] / Portée du crochet (m) / Радиус действия крюка (m) / Kancanın yüksekliği (m) / مدى الخطاف							
		25	30	35	40	45	50	55	60
60 m	37,7	6	6	6	5,4	4,2	3,2	2,4	1,7
55 m	37,8	6	6	6	5,4	4,2	3,2	2,4	—
50 m	38,1	6	6	6	5,5	4,3	3,3	—	—
45 m	38,5	6	6	6	5,6	4,4	—	—	—
40 m	38,5	6	6	6	5,6	—	—	—	—
35 m	35	6	6	6	—	—	—	—	—
30 m	30,0	6	6	—	—	—	—	—	—

 TD/2R/3R [t]			Cargas máximas / Maximum loads / Charges maximales / Максимальные нагрузки / Maksimum yük / أقصى حمولة TD/2R/3R - 6t/12t/18t									
 [m]	3R 18t @...[m]	2R 12t @...[m]	TD 6t @...[m]	Alcance del gancho [m] / Hook reach [m] / Portée du crochet (m) / Радиус действия крюка (m) / Kancanın yüksekliği (m) / مدى الخطاف								
				20	25	30	35	40	45	50	55	60
60 m	18t @...[m]	24,2	37,1	12,0	11,4	8,6	6,6	5,2	3,9	3,0	2,2	1,5
55 m				12,0	11,4	8,6	6,6	5,2	3,9	3,0	2,2	—
50 m	17,9	24,3	37,4	15,6	11,5	8,7	6,7	5,3	4,1	3,1	—	—
45 m	17,9	24,3	37,8	15,6	11,5	8,8	6,8	5,4	4,2	—	—	—
40 m	17,9	24,3	37,8	15,6	11,5	8,8	6,8	5,4	—	—	—	—
35 m	18,5	25,4	35,0	16,4	12,2	9,5	7,5	—	—	—	—	—
30 m	18,5	25,5	30,0	16,4	12,3	9,6	—	—	—	—	—	—

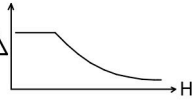





<p>*opcional *optional *en option *опция *opsiyonel *اختياري</p>					
<p>EC6074VF 44,1 kW</p>		<p>EC88110VF 65 kW</p>		<p>*EC150185VF 110 kW</p>	
					
					
					
				 400V 50Hz	
<p>TG2020VF 2x7,3 kW</p>	<p>OG1507V 2x5,5 kW</p>	<p>EP6015VF 44,1 kW</p>	<p>TH2006 15 kW</p>	<p>$P_{TOTAL}(EC88110VF + OG1507VF + EP6015VF) = 120,1 \text{ kW}$ $P_{TOTAL}(EC150185VF + OG1507VF + EP6015VF) = 165,1 \text{ kW}$</p>	
<p>0...20 m/min</p>	<p>0...0,8 r/min sl/min</p>	<p>1,5 min</p>	<p>0,6 m/min</p>	 <p>$H \leq \begin{matrix} TD & 568\text{m} \\ 2R & 284\text{m} \\ 3R & 189\text{m} \end{matrix}$</p>	
				  	

Fecha / Date: 01/09/2017

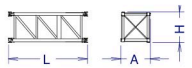
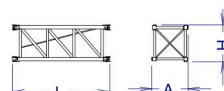
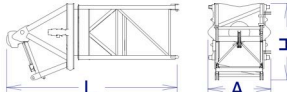
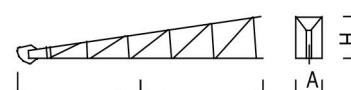
 **FEM 1005 - C25**

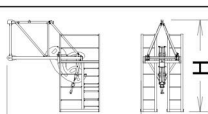
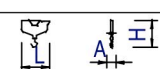
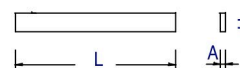
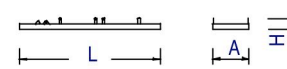
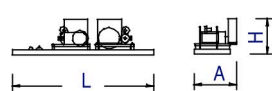

Reservado el derecho a modificaciones sin previo aviso. Declinamos toda responsabilidad derivada de la información proporcionada / Subject to modification, without previous warning. This information is supplied without liability / L'entreprise se réserve le droit de procéder à des modifications sans préavis. Nous déclinons toute responsabilité quant aux informations fournies / Мы оставляем за собой право на внесение изменений без предварительного уведомления. Мы снимаем с себя любую ответственность в отношении предоставленной информации / Önceden bildirilmeksizin değiştirilme hakkı saklıdır. Verilen bilgiler için hiçbir sorumluluk kabul etmemekteyiz / حقوق التغيير محفوظة دون إشعار مسبق. دون أدنى مسؤولية عن المعلومات المقدمة

DENOMINACIÓN / DENOMINATION / DÉSIGNATION / НАЗВАНИЕ / AÇIKLAMA / اسم		L [m]	A [m]	H [m]	P / W [kg]	
Torre inferior / Lower tower / Tour inférieure / Нижняя башня Alt kule / البرج السفلي	TLI20-5,6		5,886	2,306	2,357	4235
	TSI20-5,6		5,966	2,328	2,390	5390
	TSRI20-5,6		5,990	2,257	2,257	6562
Torre / Tower / Tour Башня / Kule / برج	TL20		4,175	2,201	2,281	2095
	TL20-5,6		5,886	2,306	2,357	2910
	TS20-5,6A		5,978	2,381	2,331	3530
	TS20-5,6		5,966	2,328	2,390	3550
	TSR20-5,6A		5,926	2,388	2,325	4170
	TSR20-5,6		5,990	2,257	2,257	4210
Torre asiento pista, base punta torre y orientación Slewing table, tower head base and slewing mechanism Tour pivot + base du porte-flèche + mécanisme d'orientation Сиденье площадки + основание верхней секции башни + поворотный механизм Döner tabla+kule kafa bölümü tabanı+mekanizma برج وحدة الدوارن + قاعدة رأس البرج + آلية الدوران			6,970	2,550	3,057	9500
Estructura punta de torre sin base Tower head structure without base Structure de porte-flèche sans base Структура верхней секции башни без основания Tabansız kule başının yapısı هيكل رأس البرج بدون قاعدة			11,58	1,910	2,033	5470
Tramo de pluma Jib section Tronçon de flèche Секция стрелы Vom bölümü أجزاء الذراع	(I)		9,180	2,040	1,765	1585
	(II)		10,160	1,266	1,565	1410
	(III)		10,160	1,266	1,565	1340
	(IV)		10,160	1,266	1,565	1190
	(V)		10,160	1,266	1,565	1000
	(VI)		5,270	1,266	1,565	580
	(VII)		5,270	1,266	1,610	770
Punta de pluma / Jib end / Pointe de flèche / Конец стрелы / Vom ucu / مقدمة الذراع			3,420	1,560	3,585	856
Polipasto / Hook assembly / Palan / Полупаст / Kanca takımı / بكرة			0,910	0,350	1,370	455
Tirante sostén pluma / Jib support tie / Tirant de fleche / Растяжка поддержки стрелы / Kol destek bağları / مشد دعامة الذراع			5,000	0,360	0,450	1232
Estructura contrapluma / Counterjib structure / Structure de contre- flèche / Структура противовесной консоли / Denge kolunun yapısı هيكل الذراع المعاكس			7,110	1,875	0,540	1145
Contrapluma con mecanismos / Counterjib with mechanisms / Contre-flèche avec mécanismes / Противовесная консоль с механизмами / Mekanizmalı denge kolu الذراع المعاكس مع الآليات			7,110	2,230	1,819	9200
Plataforma y cabina / Platform and cabin / Plateforme et cabine / Платформа и кабина / Platform ve kabin / منصة وكابينة			3,420	2,060	2,400	1095
Mecanismos Mechanisms Mécanismes de Механизмы Mekanizmalar آليات كهربائية	Elevación carga / Hoisting / levage de charge / Подъем груза / Yük kaldırma رافع الحمولة		1,919	2,110	1,540	3830
	Elevación pluma / Luffing / Relevage de flèche / Подъем стрелы / Yük kaldırma ve indirme / رافع الذراع		1,948	2,170	1,400	3250
Transporte torre de montaje/ Jacking cage transport / Transport de tour de montage / Транспортировка монтажной башни / Kaldırma kafesinin taşınması / نقل برج التركيب		TM 20PAL-5,6 	9,550	2,070	2,520	5690

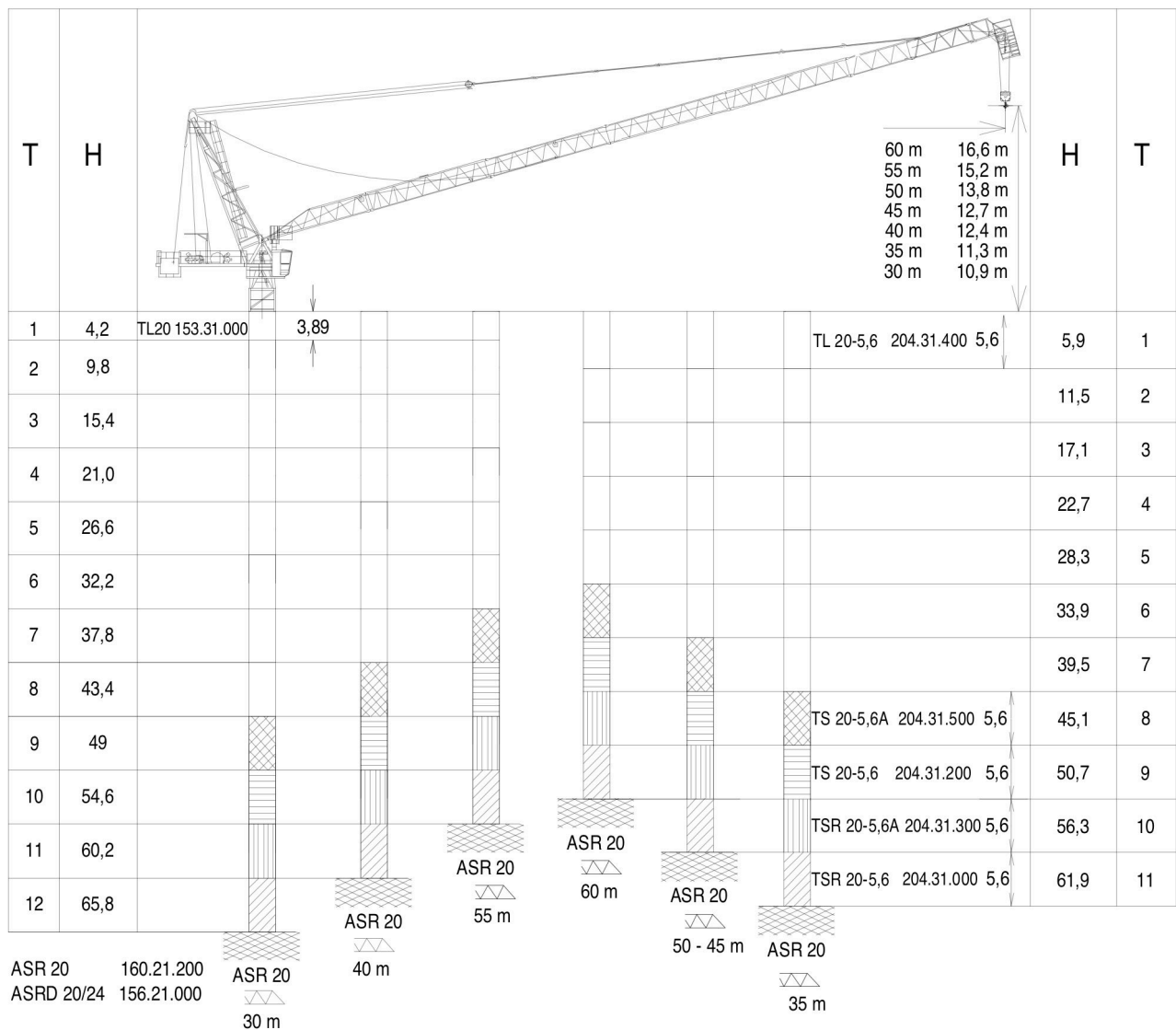

T: Torre / Tower / Tour / Башни / Kuleler / أبراج
 H: Altura / Height / Hauteur / Высота / Yükseklik / ارتفاع



Otras configuraciones de torre / Other tower configuration / Autres configurations / Прочие конфигурации / Diğer konfigürasyonlar / مكونات أخرى

TRANSPORTE / TRANSPORT / TRANSPORT / ТРАНСПОРТИРОВКА / TAŞIMA / نقل

J208PA

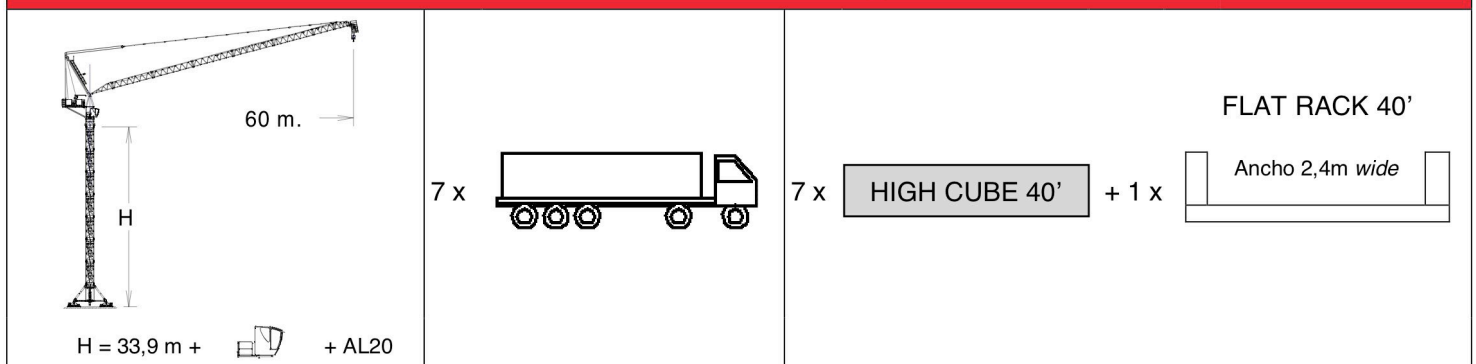

LOC & MAT

GSM : +33(0)6 11 16 84 14

E-mail : contact@locetmat.com
 Web Site : www.locetmat.com

Tél : +33(0)4 68 92 50 92

FEM 1005 - C25

Reservado el derecho a modificaciones sin previo aviso. Declinamos toda responsabilidad derivada de la información proporcionada / Subject to modification, without previous warning. This information is supplied without liability / L'entreprise se réserve le droit de procéder à des modifications sans préavis. Nous déclinons toute responsabilité quant aux informations fournies / Мы оставляем за собой право на внесение изменений без предварительного уведомления. Мы снимаем с себя любую ответственность в отношении предоставленной информации / Önceden bildirilmeksizin değiştirilme hakkı saklıdır. Verilen bilgiler için hiçbir sorumluluk kabul etmemekteyiz /

حقوق التغيير محفوظة دون إشعار مسبق. دون أدنى مسؤولية عن المعلومات المقدمة