

GRUA TORRE / TOWER CRANE

GRUE A TOUR / БАШЕННЫЙ КРАН /

رافعة برجية / KULE VINÇ

J118HPA



EN 14439
C25

UNE-EN-ISO 9001

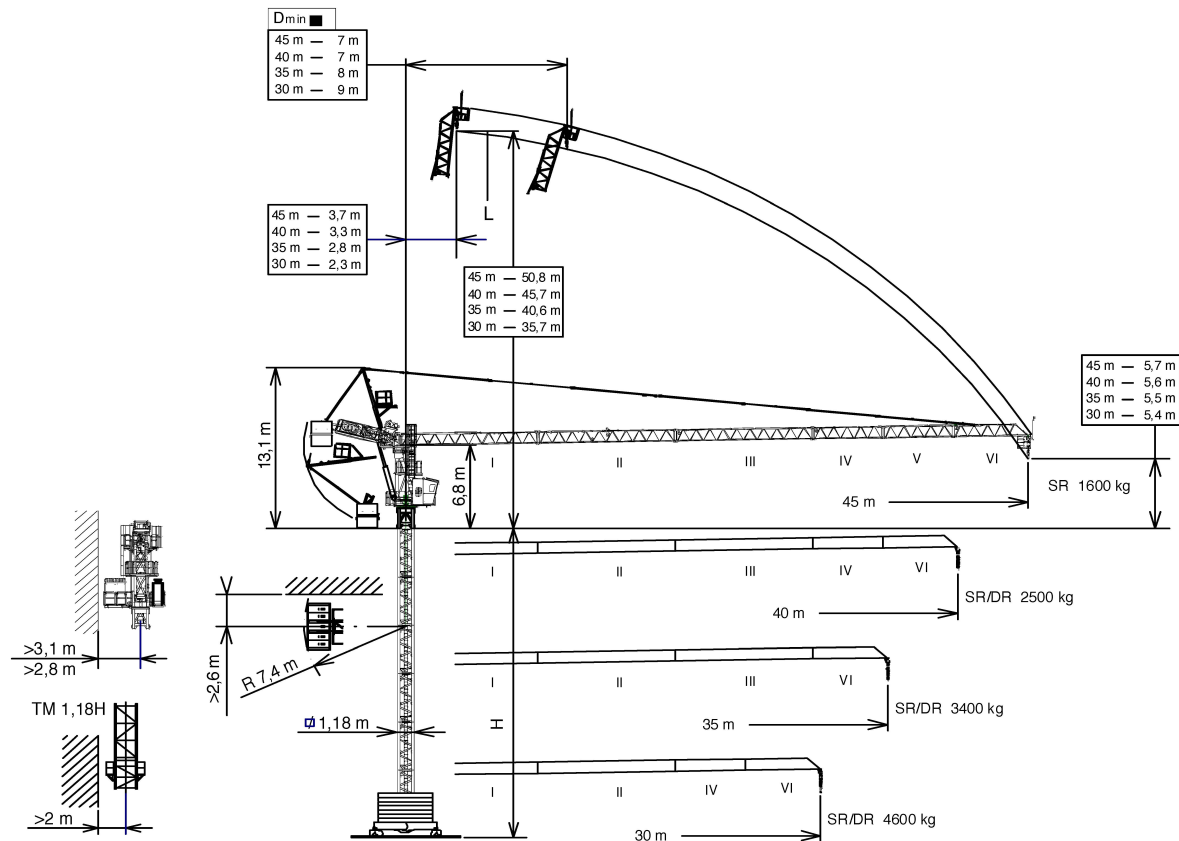

- H** Máxima altura de torre sin arriostrar (m). Maximum tower height without fastening (m). Hauteur maximale de tour sans ancrage (m). Максимальная высота башни без крепления (м). Desteksiz maksimum kule yüksekliği (m) أقصى ارتفاع للبرج بدون راس (م)
- D** Distancias fuera de servicio dependen de la altura de la torre / Out of service distance depend on tower height / Distances hors service dépendent de la hauteur de la tour / Расстояние В покое зависит от высоты башни / Odległość dewy zależy od wysokości wieży

H (D)

(H) TRASLACIÓN / TRAVELLING /
TRASLATION / ПЕРЕМЕЩЕНИЕ / RAY YÜRÜYÜŞLÜ / متحركة

(H) ESTACIONARIA / STATIONARY /
STATIONAIRE / СТАЦИОНАРНОЕ СОСТОЯНИЕ / SABIT / ثابتة

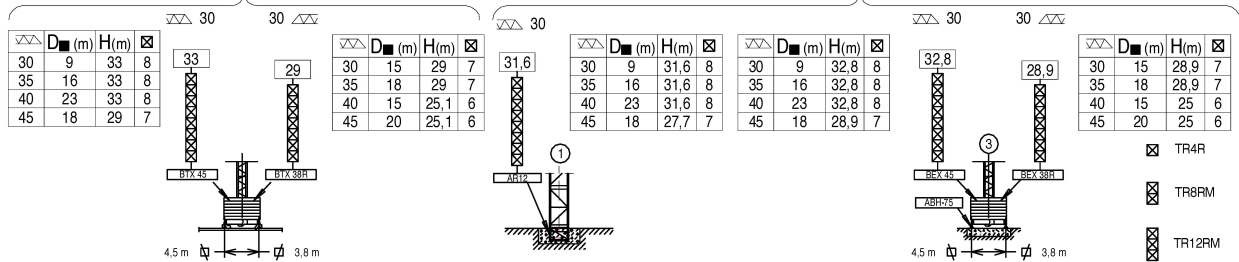

H (Dmin)

(H) TRASLACIÓN / TRAVELLING /
TRASLATION / ПЕРЕМЕЩЕНИЕ / RAY YÜRÜYÜŞLÜ / متحركة

(H) ESTACIONARIA / STATIONARY /
STATIONAIRE / СТАЦИОНАРНОЕ СОСТОЯНИЕ / SABIT / ثابتة

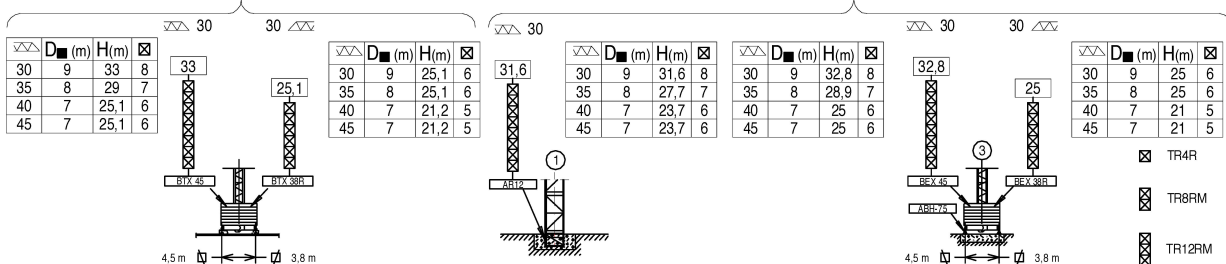

Fecha / Date: 10/06/2019



FEM 1005 - C25

Reservado el derecho a modificaciones sin previo aviso. Declinamos toda responsabilidad derivada de la información proporcionada / Subject to modification, without previous warning. This information is supplied without liability / L'entreprise se réserve le droit de procéder à des modifications sans préavis. Nous déclinons toute responsabilité quant aux informations fournies / Мы оставляем за собой право на внесение изменений без предварительного уведомления. Мы снимаем с себя любую ответственность в отношении предоставленной информации / Önceden bildirilmeksizin değiştirilme hakkı saklıdır. Verilen bilgiler için hiçbir sorumluluk kabul etmemekteyiz

630/630











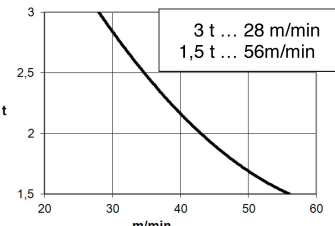
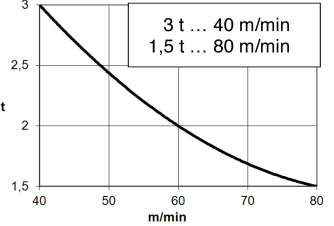

SR / DR (kg)

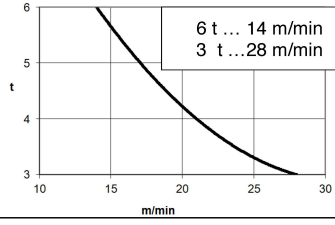
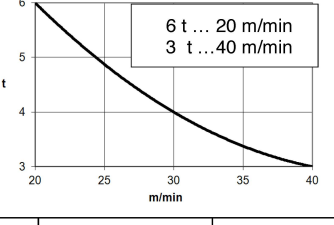
| | DR 3000 kg @ (m) | Alcance del gancho [m] / Hook reach [m] / Portée du crochet (m) / Радиус действия крюка (m) / Kancanın yüksekliği (m) / مدى الخطف | | | | | |
|------|------------------------|---|-----------|-----------|-----------|-----------|------|
| | | 20 | 25 | 30 | 35 | 40 | 45 |
| 45 m | 33,1 | 3000 | 3000 | 3000 | 2780 | 2235 | 1600 |
| 40 m | 37,3 | 3000 | 3000 | 3000 | 3000 | 2500 | — |
| 35 m | 22,7 | 35 | 3000/6000 | 3000/5435 | 3000/4425 | 3000/3400 | — |
| 30 m | 25,1 | 30 | 3000/6000 | 3000/6000 | 3000/4600 | — | — |

| | DR 5000 kg @ (m) | SR 2500 kg @ (m) | Alcance del gancho [m] / Hook reach [m] / Portée du crochet (m) / Радиус действия крюка (m) / Kancanın yüksekliği (m) / مدى الخطف | | | | |
|------|------------------------|------------------------|---|------|------|------|------|
| | | | 20 | 25 | 30 | 35 | 40 |
| 40 m | 24,7 | 40 | 5000 | 4940 | 4030 | 3315 | 2500 |

CARACTERISTICAS DE MECANISMOS / MECHANISMS FEATURES

CARACTÉRISTIQUES DES MÉCANISMES / ХАРАКТЕРИСТИКИ МЕХАНИЗМОВ / MEKANİZMALARIN ÖZELLİKLERİ / الخصائص الآلية

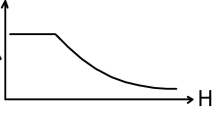



| | | | | |
|--|---|--|---|--|
| *opcional *optional *en option *опция *opsiyonel *اختياري |  | | | |
| | EC2556VF 18,4 kW | *EC3380VF 24,2 kW | | |
|  m/min |  |  | | |
|  m/min |  |  | | |
| | |  H ≤ SR 452 m DR 226 m | | |
|  |  |  |  |  400V 50Hz |
| TG825VF 2x3 kW | OG708VF 5,5 kW | EPH2015VF 15 kW | TH151 11 kW | P_{TOTAL}(EC2556VF + OG708VF + EPH2015VF) = 38,9 kW P_{TOTAL}(*EC3380VF + OG708VF + EPH2015VF) = *44,7 kW |
| 0...25 m/min | 0... 0,8 r/min sl/min | 1,5 min | 1 m/min |    |

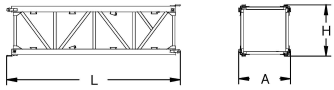
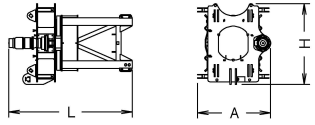
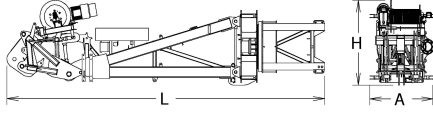
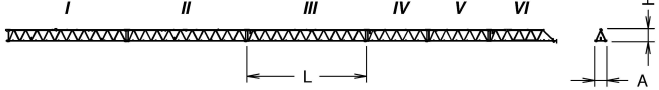
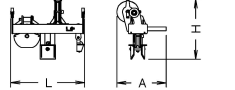
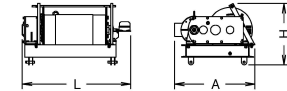
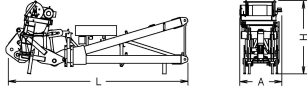
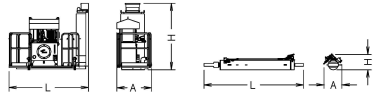
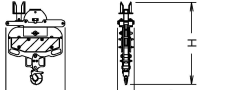

Fecha / Date: 10/06/2019

 FEM 1005 - C25

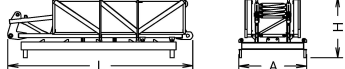
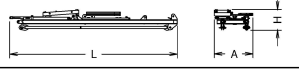
Reservado el derecho a modificaciones sin previo aviso. Declinamos toda responsabilidad derivada de la información proporcionada / Subject to modification, without previous warning. This information is supplied without liability / L'entreprise se réserve le droit de procéder à des modifications sans préavis. Nous déclinons toute responsabilité quant aux informations fournies / Мы оставляем за собой право на внесение изменений без предварительного уведомления. Мы снимаем с себя любую ответственность в отношении предоставленной информации / Önceden bildirilmeksizin değiştirilme hakkı saklıdır. Verilen bilgiler için hiçbir sorumluluk kabul etmemekteyiz / حقوق التغيير محفوظة دون إشعار مسبق. دون أدنى مسؤولية عن المعلومات المقدمة

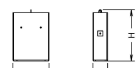
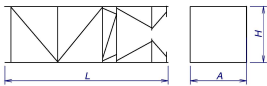
| DENOMINACIÓN / DENOMINATION / DÉSIGNATION / НАЗВАНИЕ / AÇIKLAMA / اسم | | L [m] | A [m] | H [m] | P / W [kg] |
|---|--|--|-------|-------|---|
| Torre / Tower / Tour Башня / Kule / برج | TR8RM TR12RM TR4R |  | | | 8,070 12,010 4,15 1,190 1,190 1,190 2575 3715 1430 |
| Torre asiento pista + base punta de torre + orientación Slewing table + tower head base + slewing mechanism Tour pivot + base du porte-flèche + mécanisme d'orientation Сиденье площадки + основание верхней секции башни + поворотный механизм Göbek +kule kafa bölümü tabanı+mekanizma / برج وحدة الدوارن + قاعدة رأس البرج + آلية الدوران |  | | | | 2,900 1,710 1,900 3.000 |
| Conjunto asiento pista, punta de torre, orientación y elevación Slewing table assembly, tower head, slewing and hoisting mechanism Groupe pivot + porte-flèche + mécanisme d'orientation + de levage Сиденье площадки + верхняя секция башни + поворотный механизм + подъемный механизм Göbek +kulenin kafa bölümü+mekanizma+vinç kulesi مجموعة وحدة الدوارن + رأس البرج + آلية الدوران + آلية الرفع |  | | | | 8,450 1,750 2,450 8.000 |
| Tramo de pluma Jib section Tronçon de flèche Секция стрелы Вот bölümü أجزاء الذراع | [I] [II] [III] [IV] [V] [VI] |  | | | 10,230 10,165 10,155 5,265 5,265 5,705 0,990 0,860 0,860 0,860 0,845 0,865 1,075 1,065 1,050 1,050 1,045 1,057 1.195 870 630 320 290 410 |
| Punta de pluma / Jib end / Pointe de flèche / Конец стрелы / Вот усу / مقدمة الذراع |  | | | | 0,820 0,550 0,685 90 |
| Mecanismo elevación carga / Hoisting mechanism / Mécanisme de levage/ подъемный механизм / Vinç kulesi / آلية الرفع |  | | | | 1,430 1,060 0,800 810 |
| Punta de torre + Elevación carga / Tower head + hoisting mechanism Porte-flèche + mécanisme de levage / Верхняя секция башни + подъемный механизм Kulenin kafa bölümü + Vinç kulesi / رأس البرج + آلية الرفع |  | | | | 6,100 1,500 2,455 5.000 |
| Elevación pluma con plataforma / Luffing mech + platform / Relevage de flèche + plateform + Подъем стрелы + Платформа + Yük kaldırma ve indirme + Platform / رافع الذراع + كابينة / Clindro hidráulico / Hydraulic cylinder / Cylindre hydraulique / |  | | | | 2,700 3,380 1,180 0,620 2,23 0,,535 1.130 1.350 |
| Polipasto / Hook assembly / Palan / Полуснаст / Kanca takımı / بكرة Gancho / Hook |  | | | | 0,835 0,235 1,175 220 |
| Tirante sostén pluma / Jib support tie / Tirant de fleche / Растяжка поддержки стрелы / Kol destek bağları / مشد دعامة الذراع |  | | | | 6,260 0,360 0,350 685 |
| Contrapluma con plataformas / Counterjib with platforms Contre-flèche avec plateformes / Противовесная консоль с платформами / Platformlu kuzyuk / الذراع المقابل مع المنصة |  | | | | 4,600 1,700 1,600 1.900 |
| Parte superior Top part |  | | | | 5,500 1,260 0,650 750 |
| Plataforma y cabina / Platform and cabin / Plateforme et cabine Платформа и кабина / Platform ve kabin / منصة وكابينة |  | | | | 4,150 2,100 2,500 1.200 |
| Contrapeso / Counterweight / Contrepoids / Противовес / Denge ağırlığı / اوزان معاكسة |  | | | | 1,486 1,486 0,600 0,600 2,125 0,905 4.100 1.650 |
| Lastre / Ballast / Lest / Балласт / Alt ağırlık taşları / ثقل |  | | | | 4,000 0,340 1,300 4.100 |
| Estructura torre de montaje / Jacking cage structure / Structure de tour de montage / Структура монтажной башни / Kaldırma kafesi yapısı / هيكل برج التركيب | TM 1.18H  | | | | 7,14 1,76 1,71 3300 |



Fecha / Date: 10/06/2019

Reservado el derecho a modificaciones sin previo aviso. Declinamos toda responsabilidad derivada de la información proporcionada / Subject to modification, without previous warning. This information is supplied without liability / L'entreprise se réserve le droit de procéder à des modifications sans préavis. Nous déclinons toute responsabilité quant aux informations fournies / Мы оставляем за собой право на внесение изменений без предварительного уведомления. Мы снимаем с себя любую ответственность в отношении предоставленной информации / Önceden bildirilmeksizin değiştirilme hakkı saklıdır. Verilen bilgiler için hiçbir sorumluluk kabul etmemekteyiz
حقوق التغيير محفوظة دون إشعار مسبق. دون أدنى مسؤولية عن المعلومات المقدمة

FEM 1005 - C25

| T | H | Tower Composition | | H | T |
|----|------|-------------------|------|--------|------|
| 1 | 4,1 | TR4R | 3,93 | 4,1 | 1 |
| 2 | 8 | | | 8 | 2 |
| 3 | 11,9 | TX-90/TXXR | 0,83 | 11,9 | 3 |
| 4 | 15,9 | T3-90 | 2,95 | 15,9 | 4 |
| 5 | 21,8 | T6-150A | 5,82 | 19,9 | 5 |
| 6 | 24,7 | T3-150 | 2,91 | 25,7 | 6 |
| 7 | 30,5 | T6-150 | 5,82 | 31,5 | 7 |
| 8 | 34,4 | TL20/TX150 | 3,93 | 35,4 | 8 |
| 9 | 40 | TS20-5,6A | 5,6 | 41 | 9 |
| 10 | 45,6 | TS20-5,6 | 5,6 | 46,6 | 10 |
| 11 | 51,2 | TSR20-5,6A | 5,6 | 52,2 | 11 |
| 12 | 56,8 | | | 57,8 | 12 |
| 13 | 62,4 | TSR20-5,6 | 5,6 | 63,4 | 13 |
| | | ASR 20 | 45 m | ASR 20 | 30 m |
| | | ASR 20 | 35 m | ASR 20 | 40 m |
| | | ASR 20 | 68 | ASR 20 | 68 |

T: Torre / Tower / Tour / Башни / Kuleler / أبراج
H: Altura / Height / Hauteur / Высота / Yükseklik / ارتفاع

Otras configuraciones de torre / Other tower configuration / Autres configurations / Прочие конфигурации
Diğer konfigürasyonlar / مكونات أخرى

Transporte
Transport / Transport /
Транспортировка / Taşıma / نقل

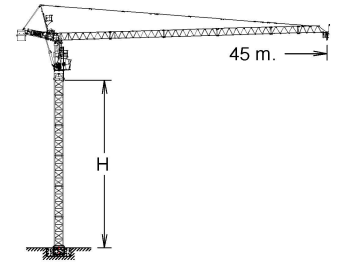

H=27,7 + AR12



4 x HIGH CUBE 40'

- 🚩 Viento fuera de servicio / Out of service wind / Vitesse du vent hors service / Ветровая нагрузка в покое / Rüzgar devre dışı / الريح خارج الخدمة
- 📄 Consultar / Consult / Nous consulter / Консультируйтесь / Danışınız / الرجوع إلى
- ▶ En servicio / In service / En service / В работе / Devrede / في الخدمة
- Fuera de servicio / Out of service / Hors service / В покое / Devre dışı / خارج الخدمة
- 📏 Distancia fuera de servicio / Out of service distance / Distance hors service / Расстояние в покое / Odległość devre dışı / الخدمة خارج الريح مسافة



LOC & MAT

GSM : +33(0)6 11 16 84 14

E-mail : contact@locetmat.com
Web Site : www.locetmat.com

Tel : +33(0)4 68 92 50 92

Reservado el derecho a modificaciones sin previo aviso. Declinamos toda responsabilidad derivada de la información proporcionada / Subject to modification, without previous warning. This information is supplied without liability / L'entreprise se réserve le droit de procéder à des modifications sans préavis. Nous déclinons toute responsabilité quant aux informations fournies / Мы оставляем за собой право на внесение изменений без предварительного уведомления. Мы снимаем с себя любую ответственность в отношении предоставленной информации / Önceden bildirilmeksizin değiştirilme hakkı saklıdır. Verilen bilgiler için hiçbir sorumluluk kabul etmemekteyiz / حقوق التغيير محفوظة دون إشعار مسبق. دون أدنى مسؤولية عن المعلومات المقدمة