

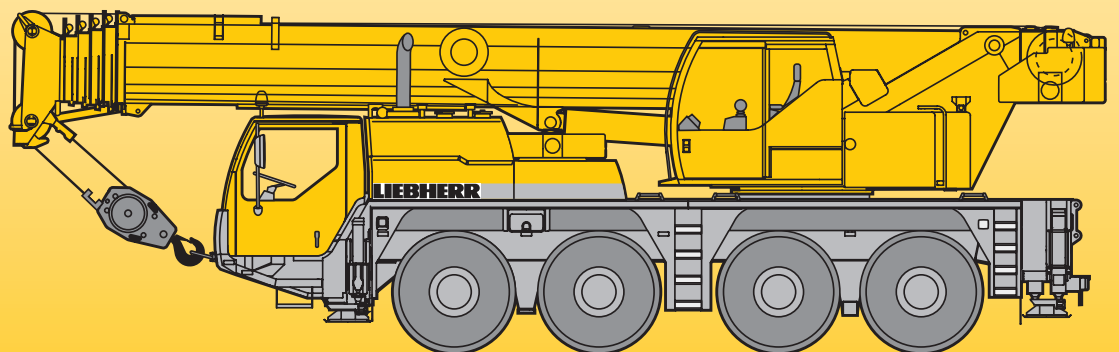

Mobile Crane Grue automotrice

LTM 1070-4.1

Technical Data Caractéristiques techniques



LIEBHERR



Lifting capacities on telescopic boom Forces de levage à la flèche télescopique

		36 - 164 ft		360°		32000 lbs		85%																			
		36 ft		48 ft		60 ft		72 ft		83 ft		95 ft		107 ft		118 ft		130 ft		142 ft		154 ft		164 ft			
ft		ft		ft		ft		ft		ft		ft		ft		ft		ft		ft		ft		ft		ft	
8	160																										8
10	147		123	122	123																						10
11	137	116	116	116	116	97.5	80																				11
12	127	110	109	110	110	96.5	79.5																				12
13	119	104	103	104	104	95	78.5	63.5																			13
14	112	98.5	98	98.5	98.5	92.5	77.5	63	50.2																		14
15	105	93.5	93	93.5	93.5	90.5	76.5	62	50.1	41																	15
18	87	80.5	81.5	81	80.5	72.5	60	48.7	40.6																		18
21	70	70	71	71	71	67.5	57.9	47.2	39.9	31.8	24.8																21
24	62.5	61	62	62.5	62.5	60.5	54.5	45.2	39	31.6	24.7	19.3															24
27			54.5	54.7	54.7	51.6	48.3	42.4	37.9	31	24.3	19.2	16.1														27
30			48.6	48.3	47.3	44.8	42.1	39.6	36	30.4	23.8	19	16.1														30
33			42.9	43.4	41.6	39.5	37.3	36.3	34	29.3	23.3	18.7	15.9														33
36			38.5	39	37.4	35.8	34.1	32.9	31.2	27.9	22.6	18.3	15.7														36
39			34.1	34.6	33.2	32.1	30.8	29.5	28.3	26.5	21.9	17.9	15.5														39
45				27.8	27.7	26.6	25.9	24.6	23.5	22.1	20.4	16.9	14.8														45
51					23.1	22.4	21.9	20.8	19.9	19.3	18.1	15.9	14.1														51
57					19.4	19.2	18.5	18.1	17.5	16.7	15.6	14.9	13.3														57
63						16.5	15.8	15.9	15.3	14.4	13.9	13.3	12.4														63
69						14.3	13.8	13.9	13.4	12.7	12.4	11.4	11.2														69
75							12.2	12.1	11.7	11.2	10.7	9.9	9.7														75
81							10.9	10.4	10.3	9.8	9.3	8.6	8.4														81
87								9.3	9.1	8.6	8.1	7.4	7.3														87
93								8.4	8	7.6	7.1	6.4	6.3														93
99									7.2	6.7	6.2	5.6	5.5														99
105										5.9	5.4	4.8	4.7														105
111										5.3	4.8	4.2	4.1														111
117										4.7	4.2	3.6	3.5														117
123											3.7	3.1	3														123
129											3.2	2.5	2.5														129
135												2.1	2.1														135

* over rear / en arrière





TAB 153232 / 153539

		36 - 164 ft		360°		23600 lbs		85%																			
		36 ft		48 ft		60 ft		72 ft		83 ft		95 ft		107 ft		118 ft		130 ft		142 ft		154 ft		164 ft			
ft		ft		ft		ft		ft		ft		ft		ft		ft		ft		ft		ft		ft		ft	
10	111		111	111																							10
11	105	105	105	105	88.5	73																					11
12	99	98.5	99	99	87.5	72.5																					12
13	93.5	93.5	93.5	93.5	86	71.5	57.9																				13
14	88.5	88.5	88.5	84.5	70.5	57.3	45.7																				14
15	83.5	83.5	84	82.5	69.5	56.6	45.6	37.2																			15
18	72	73	73	73	66	54.6	44.3	36.9																			18
21	62	63	63	62.5	59.2	51.5	43	36.3	28.9	22.6																	21
24	53.3	54.4	54.3	53.4	49.8	46.2	41	35.5	28.7	22.4	17.6																24
27		47.5	46.9	45.5	42.6	40	37.8	34.3	28.2	22.1	17.5	14.6															27
30		41	41.4	39.4	37.1	35.2	33.6	31.6	27.6	21.6	17.2	14.6															30
33		34.7	35.6	34.6	33.3	31.7	30	28.6	26.5	21.1	17	14.5															33
36		30.4	31.3	31	30	28.7	27.1	25.8	24	20.5	16.6	14.3															36
39		26.1	27	27.4	26.6	25.8	24.3	23.1	21.5	19.9	16.3	14.1															39
45			21.4	21.8	22	21.3	20.6	19.5	18.6	17.2	15.4	13.5															45
51				17.9	18.1	17.7	17.4	16.7	15.7	15.2	14	12.8															51
57				15.1	15.1	14.9	14.9	14.2	13.7	13.1	12.1	11.6															57
63					12.8	12.8	12.7	12.3	11.9	11.2	10.2	10															63
69					11	11.2	10.9	10.6	10.2	9.6	8.7	8.5															69
75						9.7	9.5	9.2	8.7	8.2	7.4	7.3															75
81						8.5	8.3	8	7.5	7	6.3	6.2															81
87							7.2	7	6.5	6.1	5.4	5.3															87
93							6.3	6.1	5.7	5.2	4.6	4.4															93
99								5.3	4.9	4.5	3.8	3.7															99
105									4.2	3.8	3.2	3.1															105
111									3.6	3.2	2.6	2.5															111
117									3	2.7	2.1	2															117
123										2.2																	123

TAB 153518







Lifting capacities on telescopic boom Forces de levage à la flèche télescopique

    							
ft	36 ft		48 ft		60 ft		ft
	32000 lbs	23600 lbs	32000 lbs	23600 lbs	32000 lbs	23600 lbs	
10	30.2	29.5	31.6	30.9	32.3	31.5	10
11	28.1	27.4	29.5	28.8	30.2	29.5	11
12	26.1	25.5	27.6	26.9	28.2	27.6	12
13	24.3	23.7	25.8	25.2	26.5	25.8	13
14	22.8	22.2	24.2	23.6	24.9	24.3	14
15	21.3	20.7	22.8	22.2	23.5	22.9	15
18	17.7	17.2	19.2	18.7	19.9	19.4	18
21	14.8	14.3	16.3	15.8	17	16.5	21
24	12.4	12	13.9	13.5	14.6	14.2	24
27			11.9	11.6	12.7	12.3	27
30			10.3	9.9	11	10.7	30
33			8.9	8.6	9.6	9.3	33
36			7.8	7.5	8.5	8.2	36
39			6.7	6.4	7.4	7.1	39
45					5.7	5.5	45

0° = over rear / en arrière
Tyre size / dimensions de pneumatiques: 16.00 R 25, 20.5 R 25

TAB 153200 / 153203

   							
ft	36 ft		48 ft		60 ft		ft
	13	18.5		18.1			
14	17.1		17.5				14
15	15.7		16.8		15.9		15
18	12.3		13.8		14.1		18
21	9.7		11.1		11.9		21
24	7.7		9.1		9.7		24
27			7.5		8.1		27
30			6.2		6.9		30
33					5.8		33
36					4.8		36
39					3.9		39

Tyre size / dimensions de pneumatiques: 16.00 R 25, 20.5 R 25

TAB 153219

Remarks referring to load charts

1. The tabulated lifting capacities do not exceed 85% of the tipping load.
2. The crane's structural steelwork is in accordance with DIN 15018, part 3. Design and construction of the crane comply with DIN 15018, part 2, and with F. E. M. regulations.
3. The 85% overturning limit values take into account wind force 5 = wind speed 20 mph.
4. Lifting capacities are given in kips.
5. The weight of the hook blocks and hooks must be deducted from the lifting capacities.
6. Working radii are measured from the slewing centreline.
7. The lifting capacities given for the telescopic boom only apply if the folding jib is taken off.
8. Subject to modification of lifting capacities.
9. Lifting capacities above 130 kips only with additional pulley block.

Remarques relatives aux tableaux des charges

1. Les forces de levage indiquées ne dépassent pas 85% de la charge de basculement.
2. La norme DIN 15018, 3ème partie est appliquée pour les charpentes. La construction de la grue est réalisée conformément à la norme DIN 15018, 2ème partie, et aux règles de la F. E. M.
3. A 85% de la charge de basculement, il a été tenu compte d'un vent de force 5 = vitesse de vent 20 mph.
4. Les forces de levage sont données en kips.
5. Les poids des moufles et crochets doit être soustrait des charges indiquées.
6. Les portées sont calculées à partir de l'axe de rotation.
7. Les forces indiquées pour la flèche télescopique s'entendent fléchette dépliée déposée.
8. Charges données sous réserve de modification.
9. Les charges supérieures à 130 kips ne peuvent être levées qu'avec poulie supplémentaire.



Lifting heights Hauteurs de levage

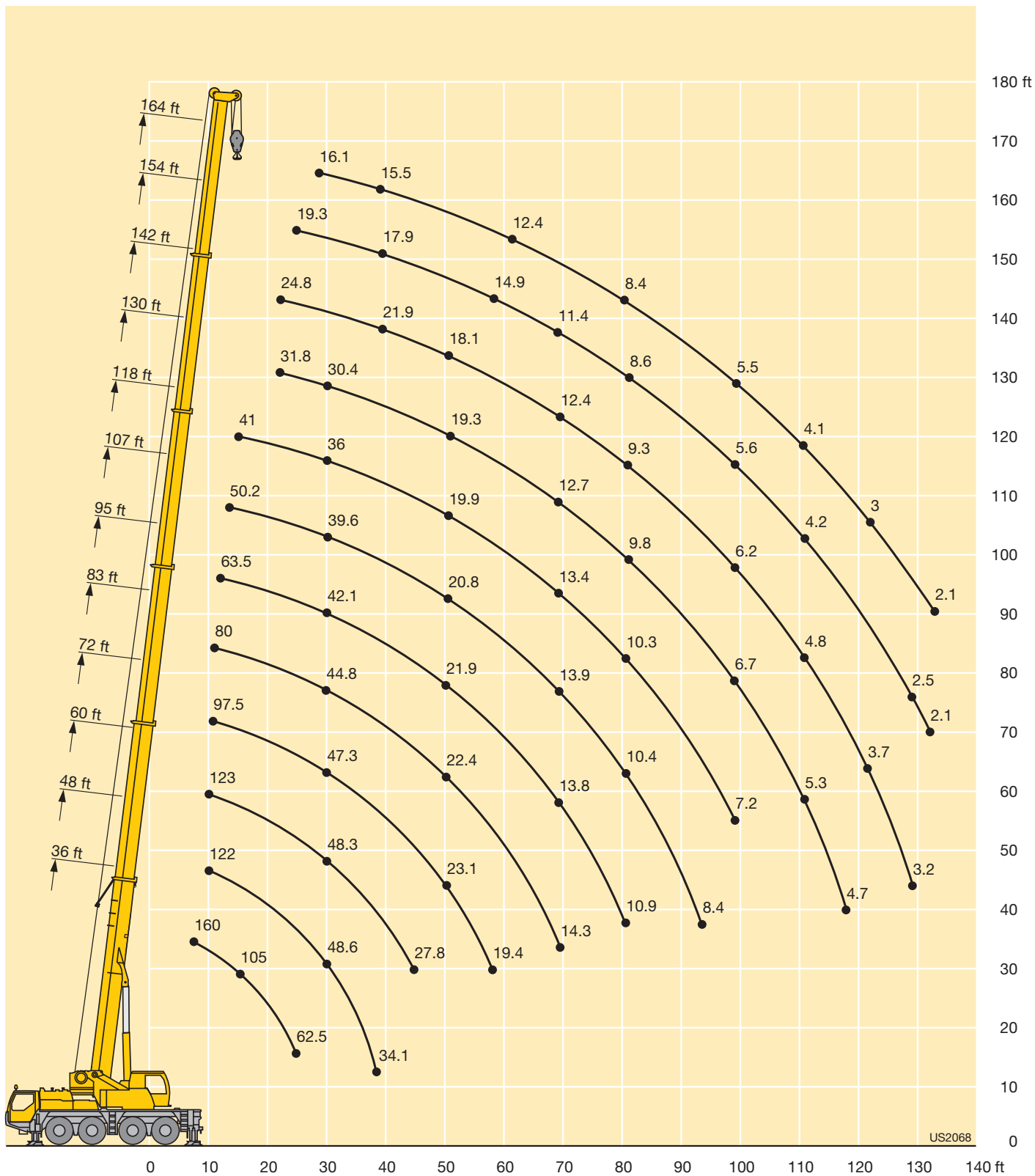

US2068



Lifting capacities on the folding jib Forces de levage à la fléchette pliante



ft	36 ft				48 ft				60 ft				72 ft				83 ft				95 ft				ft					
	31 ft				31 ft				31 ft				31 ft				31 ft				31 ft									
	0°	20°	40°	60°	0°	20°	40°	60°	0°	20°	40°	60°	0°	20°	40°	60°	0°	20°	40°	60°	0°	20°	40°	60°						
10	25.1				25.1				25.1				25.1				25.1				25.1				25.1					10
11	25.1				25.1				25.1				25.1				25.1				25.1				25.1					11
12	25.1				25.1				25.1				25.1				25.1				25.1				25.1					12
13	25.1	23.4			25.1				25.1				25.1				25.1				25.1				25.1					13
14	25.1	22.8			25.1	23.2			25.1				25.1				25.1				25.1				25.1					14
15	25.1	22.2			25.1	23.1			25.1	22.8			25.1				25.1				25.1				25.1					15
18	25.1	20.7			25.1	21.6			25.1	22.1			25.1	21.3			25.1	21.4			25.1				25.1					18
21	25.1	19.4	15		25.1	20.4	15.3		25.1	20.9			25.1	20.9			25.1	21			25.1	19.8			25.1					21
24	25.1	18.3	14.8		25.1	19.3	15.1		25.1	19.9	14.9		25.1	20	14.9		25.1	20.1			25.1	19.5			25.1	19.5				24
27	24.7	17.3	14.4	11.5	25.1	18.3	14.7	11.4	25.1	19	14.8		25.1	19.1	14.8		25.1	19.3	14.6		25.1	18.8	14.4		25.1	18.8	14.4			27
30	23.1	16.3	13.9	11.2	25.1	17.5	14.2	11.4	25.1	18.1	14.5	11.5	25.1	18.4	14.5	11.4	25.1	18.6	14.5	11.4	25.1	18.2	14.3		25.1	18.2	14.3			30
33	21.1	15.6	13.5	11	24.6	16.6	13.8	11.2	25.1	17.4	14.1	11.3	25.1	17.6	14.2	11.3	25.1	18	14.2	11.4	25.1	17.6	14.1		25.1	17.6	14.1			33
36	19.3	15	13	10.8	22.9	16	13.4	11	24.4	16.8	13.8	11.1	24.9	17.1	13.9	11.2	25.1	17.4	13.9	11.3	24.6	17.1	13.7		25.1	17.1	13.7			36
39	17.6	14.4	12.5	10.7	21.3	15.3	12.9	10.8	23.8	16.1	13.4	10.9	24.6	16.5	13.7	11	25.1	16.8	13.6	11.1	24.2	16.6	13.3	11.1	25.1	16.6	13.3	11.1		39
45	14.7	13.3	11.8	10.7	18.2	14.4	12.3	10.6	21.1	15.1	12.7	10.7	22.5	15.5	13	10.8	22.5	15.9	13	10.9	22.4	15.8	12.8	10.9	25.1	15.8	12.8	10.9		45
51	12.8	12.4	11.4	10.7	15.8	13.5	11.8	10.6	18.4	14.3	12.2	10.6	20.2	14.7	12.5	10.6	19	15.1	12.5	10.7	19.2	15.1	12.5	10.7	25.1	15.1	12.5	10.7		51
57	11	11.8			13.8	12.6	11.5	10.6	16.3	13.6	11.8	10.5	17.4	14	12	10.6	16	14.4	12.2	10.6	16.3	14.5	12.2	10.6	25.1	14.5	12.2	10.6		57
63					12.2	12	11.4		14.4	12.9	11.5	10.5	15	13.4	11.7	10.5	13.6	13.8	11.9	10.6	13.9	13.9	11.9	10.6	25.1	13.9	11.9	10.6		63
69									12.8	12.3	11.4	10.5	12.8	12.7	11.5	10.5	11.6	12.4	11.7	10.5	12	12.7	11.7	10.5	25.1	12.7	11.7	10.5		69
75									11.3	11.4	11.1		10.9	11.5	11.1	10.5	10	10.7	10.9	10.3	10.4	11.1	11.2	10.5	25.1	11.1	11.2	10.5		75
81													9.4	9.8	10		8.5	9.1	9.4	9.5	9	9.6	10	10	25.1	9.6	10	10		81
87													8.2	8.5			7.3	7.8	8	7.9	7.8	8.3	8.6	8.7	25.1	8.3	8.6	8.7		87
93																	6.3	6.6	6.8		6.8	7.2	7.4	7.4	25.1	7.2	7.4	7.4		93
99																	5.3	5.6			5.9	6.2	6.4		25.1	6.2	6.4			99
105																					5	5.3	5.4		25.1	5.3	5.4			105
111																					4.3	4.5	4.4		25.1	4.5	4.4			111
117																					3.6				25.1	3.6				117

TAB 153498 / 153499 / 153500 / 153501



ft	107 ft				118 ft				130 ft				142 ft				154 ft				164 ft				ft						
	31 ft				31 ft				31 ft				31 ft				31 ft				31 ft										
	0°	20°	40°	60°	0°	20°	40°	60°	0°	20°	40°	60°	0°	20°	40°	60°	0°	20°	40°	60°	0°	20°	40°	60°							
14	25.1																								25.1					14	
15	25.1																														15
18	25.1																														18
21	25.1																														21
24	25.1	18.5																													24
27	25	18.4																													27
30	24.5	17.8	14																												30
33	23.9	17.3	14																												33
36	23.4	16.8	13.6																												36
39	22.8	16.4	13.2	11.1																											39
45	20.8	15.6	12.8	10.9																											45
51	17.7	15	12.4	10.7																											51
57	14.9	14.5	12.1	10.6																											57
63	13.1	13.3	11.9	10.6																											63
69	11.9	11.7	11.6	10.5																											69
75	10.6	10.3	10.7	10.3																											75
81	9.2	9.5	9.5	9.7																											81
87	8.1	8.6	8.8	9																											87
93	7.1	7.5	7.8	7.9																											93
99	6.2	6.5	6.8	6.8																											99
105	5.4	5.7	5.9	5.8																											105
111	4.7	5	5.1	5																											111
117	4	4.2	4.3																												117
123	3.4	3.6																													123
129																															129
135																															135
141																															141
147																															147

TAB 153498 / 153499 / 153500 / 153501



Lifting capacities on the folding jib Forces de levage à la fléchette pliante



ft	36 ft				48 ft				60 ft				72 ft				83 ft				95 ft				ft
	52 ft				52 ft				52 ft				52 ft				52 ft				52 ft				
	0°	20°	40°	60°	0°	20°	40°	60°	0°	20°	40°	60°	0°	20°	40°	60°	0°	20°	40°	60°	0°	20°	40°	60°	
10	19.1				19.3				18.9																10
11	18.7				19				18.7																11
12	18.3				18.7				18.5																12
13	17.9				18.4				18.3														16.5		13
14	17.4				18				18														16.4		14
15	17				17.7				17.7														16.4		15
18	15.6				16.6				16.8																18
21	14.4	9.6			15.4				15.9																21
24	13.5	9.4			14.3	9.2			15	9.4															24
27	12.5	8.9			13.5	9.1			14.1	9.3															27
30	11.6	8.4			12.7	8.7			13.2	8.9															30
33	10.8	8			11.9	8.3			12.5	8.5															33
36	10	7.6			11.2	7.9			11.7	8.2															36
39	9.3	7.3	6.1		10.5	7.6	6.2		11	7.8	6.3														39
45	8.4	6.7	5.8		9.2	7.1	5.9		10	7.3	6														45
51	7.6	6.2	5.5	5.3	8.4	6.6	5.6	5.3	9	6.8	5.7	5.3													51
57	6.9	5.8	5.3	5.2	7.7	6.2	5.4	5.2	8.3	6.5	5.5	5.3	8.7	6.6	5.6	5.3									57
63	6.3	5.5	5.1	5.1	7.1	5.8	5.2	5.1	7.7	6.1	5.4	5.2	8.1	6.3	5.4	5.2									63
69	5.8	5.3	5.1		6.5	5.6	5.1	5.1	7.1	5.8	5.2	5.1	7.6	6	5.3	5.1									69
75	5.4	5.1			6	5.3	5	5.1	6.6	5.6	5.1	5.1	7.1	5.7	5.1	5.1									75
81					5.6	5.1	5		6.2	5.3	5	5.1	6.6	5.5	5.1	5.1									81
87					5.3				5.8	5.2	5		6.2	5.3	5	5.1									87
93									5.5	5.1	5		5.9	5.2	5	5.1									93
99													5.6	5	5										99
105													5.3	5											105
111													5.1	5											111
117																									117
123																									123
129																									129
135																									135

TAB 153498 / 153499 / 153500 / 153501



ft	107 ft				118 ft				130 ft				142 ft				154 ft				164 ft		ft		
	52 ft				52 ft				52 ft				52 ft				52 ft				52 ft				
	0°	20°	40°	60°	0°	20°	40°	60°	0°	20°	40°	60°	0°	20°	40°	60°	0°	20°	40°	60°	0°	20°			
15	13.9																							15	
18	13.7				10.8																				18
21	13.2				10.8				9.9																21
24	12.8				10.7				9.9																24
27	12.5				10.6				9.9																27
30	12.1				10.5				9.7																30
33	11.8				10.3				9.5																33
36	11.4				10.1				9.4																36
39	11	7.9			10	7.5			9.2																39
45	10.4	7.5			9.6	7.2			8.9	7															45
51	9.8	7.2	5.7		9.2	6.9	5.6		8.7	6.8															51
57	9.2	6.9	5.6	5.2	8.9	6.6	5.5		8.5	6.6	5.4														57
63	8.7	6.6	5.5	5.1	8.5	6.4	5.4	5.1	8.2	6.3	5.3	5													63
69	8.3	6.3	5.3	5.1	8.1	6.2	5.3	5	7.9	6.1	5.2	5													69
75	7.8	6.1	5.2	5	7.8	6	5.2	5	7.7	5.9	5.1	5													75
81	7.4	5.9	5.1	5	7.5	5.8	5.1	5	7.4	5.8	5.1	4.9													81
87	7.1	5.7	5.1	5	7.2	5.6	5	5	6.9	5.6	5	4.9													87
93	6.8	5.5	5	5	6.8	5.5	4.9	5	6	5.5	4.9	4.9													93
99	6.5	5.4	4.9	5	6	5.3	4.9	5	5.4	5.4	4.9	4.9													99
105	5.9	5.3	4.9	5	5.2	5.2	4.9	5	5.1	5.2	4.9	4.9													105
111	5.2	5.1	4.9	5	4.5	5.1	4.9	5	4.7	4.9	4.8	4.9													111
117	4.6	5	4.9	5	3.9	4.6	4.9	5	4.1	4.6	4.7	4.8													117
123	4	4.5	4.6	4.6	3.4	3.9	4.3	4.4	3.6	4.2	4.5	4.6													123
129	3.5	3.9	4.1	3.9	2.9	3.4	3.7	3.7	3.1	3.6	4	4.1													129
135	3	3.3	3.4		2.4	2.9	3.1	3	2.7	3.1	3.5	3.5													135
141	2.5	2.8			2	2.4	2.5		2.3	2.7	2.9	2.9													141
147	2.1				1.6	1.9	1.9		1.9	2.2	2.4	2.2													147
153																									153

TAB 153498 / 153499 / 153500 / 153501



Lifting heights Hauteurs de levage

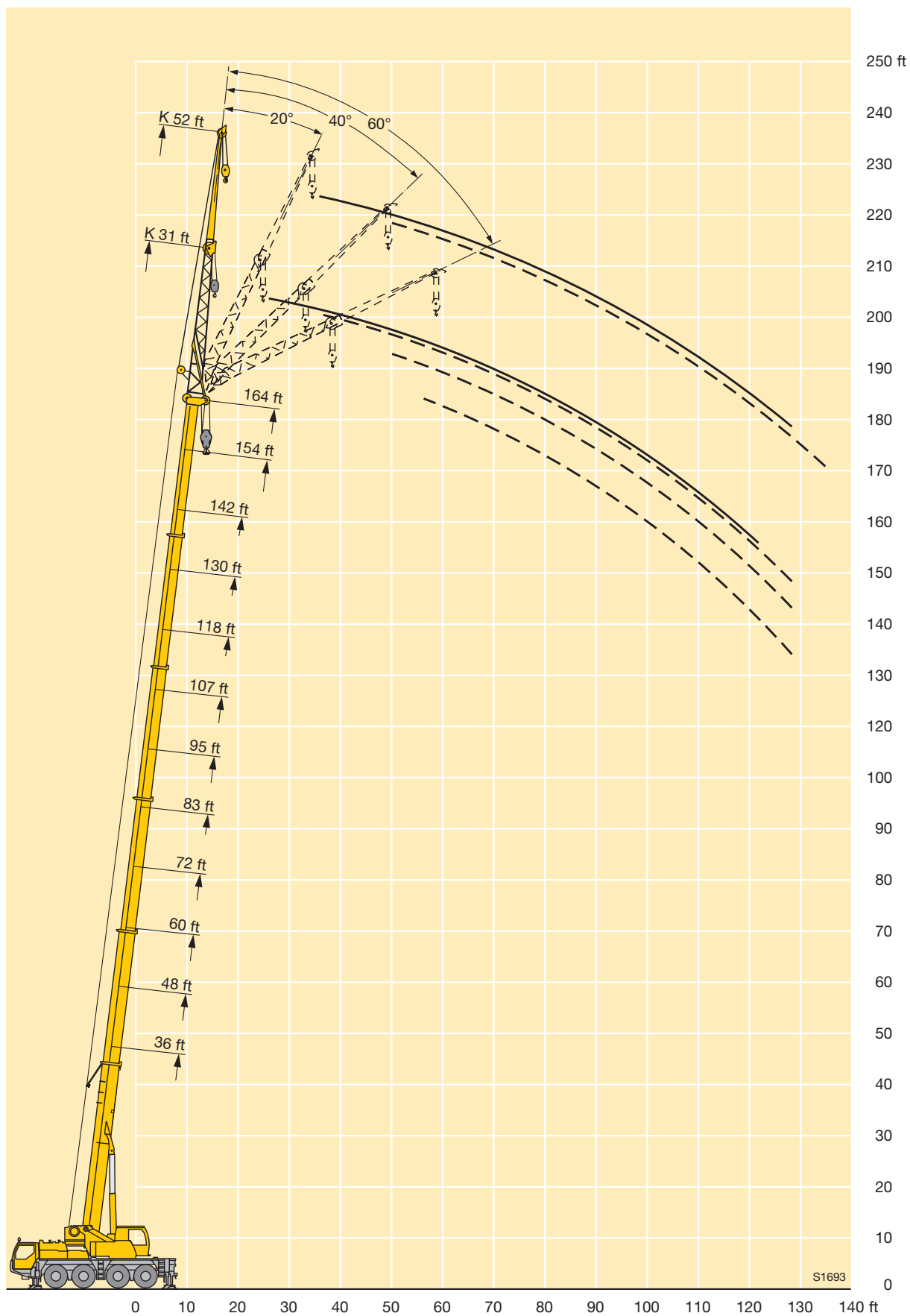



Lifting heights Hauteurs de levage

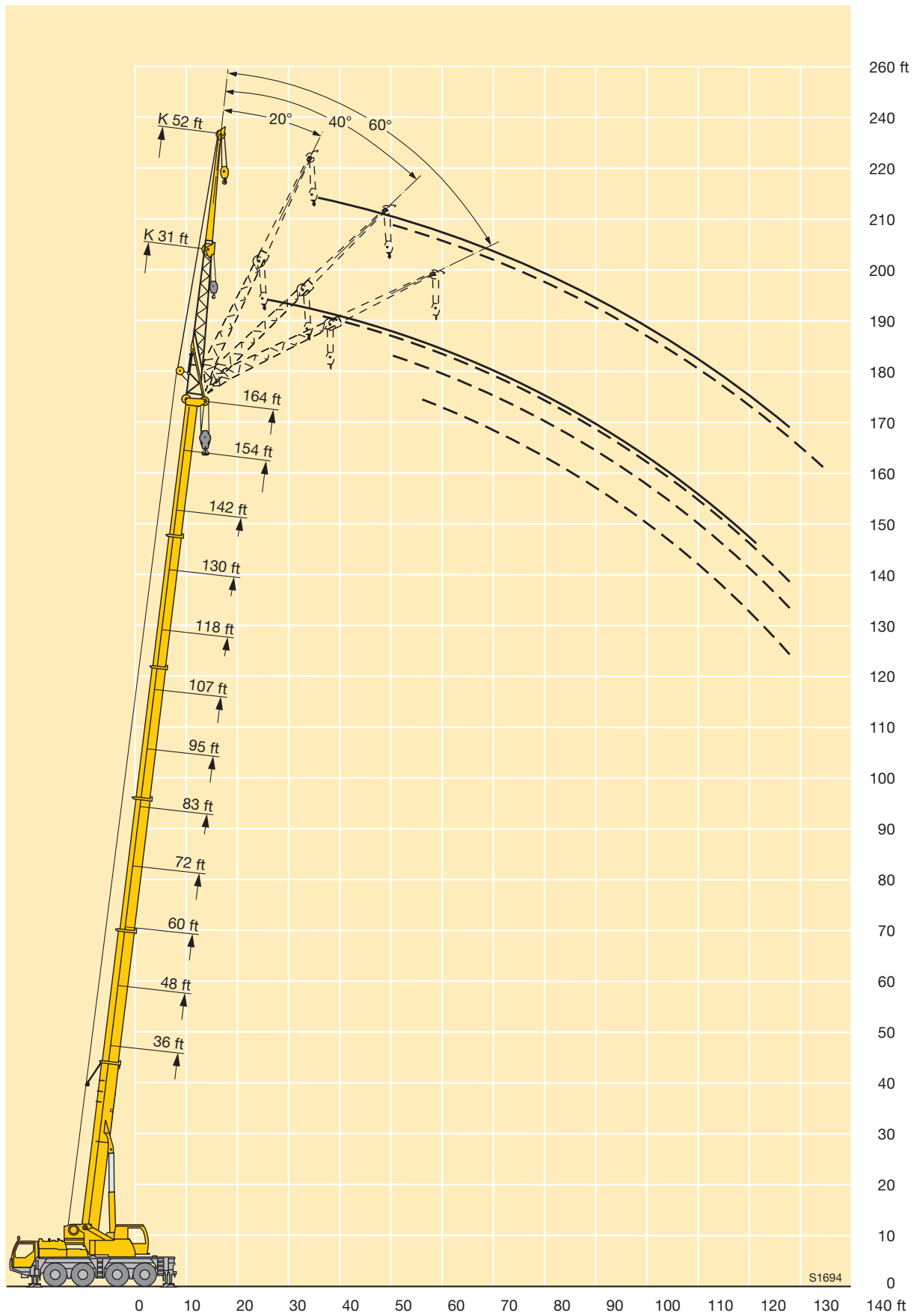



Lifting capacities on the erection jib Forces de levage à la flèche de montage



ft	36 ft				48 ft				60 ft				72 ft				83 ft				95 ft				ft				
	10 ft				10 ft				10 ft				10 ft				10 ft				10 ft								
	0°	20°	40°	60°	0°	20°	40°	60°	0°	20°	40°	60°	0°	20°	40°	60°	0°	20°	40°	60°	0°	20°	40°	60°					
10		70.5	64.5	54.2			67	55.3				68	56.3												10				
11		70.5	63	53.6			70.5	66	54.4				67	55.5											11				
12		70.5	61.5	52.9			70.5	65	53.6				65.5	54.7											12				
13		70.5	59.9	52			70.5	63.5	52.9				64.5	54.1					61						13				
14		70.5	58.6	51.2			70.5	62.5	52.1				63.5	53.4					60	52.2				54	14				
15		70	57.3	50.4			70.5	61	51.4				70.5	62.5	52.7					59.5	52.1			53.8	47.2	15			
18		65	54	48.4			70	58	49.5				70.5	59.5	51				70.5	60	51.5			57.6	50.7	18			
21	68	60.5	51.2	46.7			67.5	55.2	47.9				68	57	49.4				67.5	57.8	50.1			60.5	55.3	49.4	21		
24	61.5	56.3	48.8	45.4			61.5	52.8	46.5				62	54.7	48.1				59.3	55.3	48.8			54.4	52.2	48.1	24		
27	53.8	52.6	46.7	44.4	53.8	54.4	50.5	45.4					53.6	51.8	46.8				50.4	51.3	47.5			47.1	47.5	46.1	27		
30	47.6	48.1	45.1	43.9	47.6	48.1	48	44.4					46.2	46.9	45.4				43.8	44.3	45			42.6	41.3	41.8	30		
33		42.5	42.8		41.9	42.5	42.9	43.2					40.5	41.1	41.6				39.5	38.9	39.4			37.5	37.9	36.6	33		
36		38.2	38.4		37.6	38.1	38.5	38.8					36.3	36.8	37.3				35.6	35.5	35.5			33.7	34.2	33.7	36		
39		33.9	33.9		33.3	33.7	34	34.3	32.2	32.1	32.5	32.9							31.7	32.1	31.6			29.9	30.4	30.7	39		
45					26.9	27.2	27.4	27.4	27	27.1	27.4	27.4							26.1	26.4	26.5			24.6	24.9	25.3	45		
51									22.5	22.8	23	23	21.6	21.8	22.1	22.3				20.9	20.8	21.1			20.9	20.8	21.1	51	
57									18.9	19.1	19.2	19.2	18.2	18.5	18.7	18.9	17.7	18	18	18.2				14.9	15.1	15.3	15.4	57	
63													15.7	15.7	15.9	15.9	15.4	15.4	15.6	15.7	13.5	13.5	13.6	13.7	12.8	13	13.1	13.2	63
69													13.6	13.6	13.6	13.6				13.5	13.5	13.6	13.7	11.7	11.8	11.9	11.9	69	
75																				11.7	11.8	11.9	11.9	11	11.1	11.3	11.3	75	
81																				10.2	10.3	10.3			9.6	9.7	9.8	9.8	81
87																									8.6	8.7	8.7	8.8	87
93																										7.9			93

TAB 153502 / 153503 / 153504 / 153505



ft	107 ft				118 ft				130 ft				142 ft				154 ft				164 ft				ft					
	10 ft				10 ft				10 ft				10 ft				10 ft				10 ft									
	0°	20°	40°	60°	0°	20°	40°	60°	0°	20°	40°	60°	0°	20°	40°	60°	0°	20°	40°	60°	0°	20°	40°	60°						
18			43.6	43.1			32.9																					18		
21			43.1	42.3			32.4	30.6				26																21		
24			41.7	40.6			31.3	30.1				25.8	25.3			20.4												24		
27		39.6	39.5	38.9			30.1	28.8				25.3	25.1			20.3	20.3							15.7	15.9		11.7	27		
30		37	37.1	37.1		30.7	28.9	27.7				24.6	24.3			19.9	20.2							15.7	15.9		11.7	30		
33		33.1	33.7	34.3		29.5	27.8	26.6			24.6	23.9	23.5			19.5	19.7							15.5	15.5		11.6	33		
36		30.3	30.3	30.8		27.6	26.7	25.6			23.8	23.1	22.8			19	19.1							15.1	15.2		11.5	36		
39		27.5	26.8	27.3		25.8	25.6	24.6			23	22.4	22			18.5	18.5	18.5					15	14.8	14.9		11.4	39		
45		23	22.9	23.2		21.9	22.1	21.8			20.5	20.8	20.6			17.4	17.2	17.2					14.3	14.1	14		11.1	45		
51		19.5	19.7	19.8		18.4	18.7	18.9			17.3	17.7	17.9			16.2	15.9	15.8					13.5	13.3	13.1	10.6	10.6	51		
57		16.6	16.8	17		15.6	15.9	16.1			15	15.3	15.4			14.1	14.3	14.4					12.6	12.5	12.1	10.2	10.1	57		
63		14.5	14.6	14.7		13.7	13.7	13.8			13.2	13.4	13.5			12.4	12.3	12.5					11.6	11.6	11.4	9.7	9.7	63		
69	12.6	12.7	12.8	12.8		12.1	12.1	12.2			11.4	11.6	11.8			11	10.9	11					10.2	10.4	10.4	9.2	9.2	69		
75	11	11.1	11.1	11.2	10.3	10.5	10.7	10.8			9.9	10.1	10.2			9.6	9.8	9.8					8.7	8.9	9.1	8.5	8.5	75		
81	9.6	9.7	9.7	9.8	9.1	9.2	9.3	9.4	8.7	8.8	8.9	8.9			8.3	8.4	8.6					7.4	7.6	7.7	7.4	7.6	7.7	81		
87	8.4	8.5	8.6	8.6	8.2	8.3	8.3	8.3	7.6	7.8	7.9	8	6.9		7.1	7.3	7.4					6.3	6.5	6.6	6.3	6.5	6.6	87		
93	7.4	7.5	7.5	7.6	7.2	7.3	7.4	7.5	6.6	6.8	6.9	7	6	6.1	6.3	6.4	5.1	5.3	5.5	5.6	5.3	5.5	5.6	5.3	5.5	5.6	5.3	93		
99	6.6	6.7	6.7	6.7	6.3	6.4	6.5	6.5	5.8	5.9	6	6.1	5.1	5.3	5.4	5.5	4.3	4.5	4.6	4.7	4.5	4.6	4.7	4.5	4.6	4.7	4.5	99		
105					5.6	5.6	5.7	5.7	5	5.1	5.2	5.3	4.4	4.5	4.6	4.7	3.6	3.8	3.9	3.9	3.8	3.9	3.9	3.8	3.9	4	4	105		
111					4.8	4.9	5	5	4.3	4.4	4.5	4.5	3.7	3.9	4	4	3	3.1	3.2	3.3	3.1	3.2	3.3	3.1	3.2	3.3	3.1	111		
117					4.2	4.3	4.3	4.2	3.6	3.7	3.8	3.8	3.2	3.3	3.4	3.4	2.4	2.5	2.6	2.7	2.5	2.6	2.7	2.5	2.6	2.7	2.5	117		
123									3	3.1	3.2	3.2	2.6	2.7	2.8	2.8	1.9	2	2.1	2.1	2	2.1	2	2.1	2.1	2.1	2.1	123		
129									2.5	2.6	2.6	2.6	2	2.1	2.2	2.2								1.5	1.6	1.6	1.5	1.6	1.6	129
135													1.6	1.7	1.7	1.7													135	

TAB 153502 / 153503 / 153504 / 153505



Lifting heights Hauteurs de levage

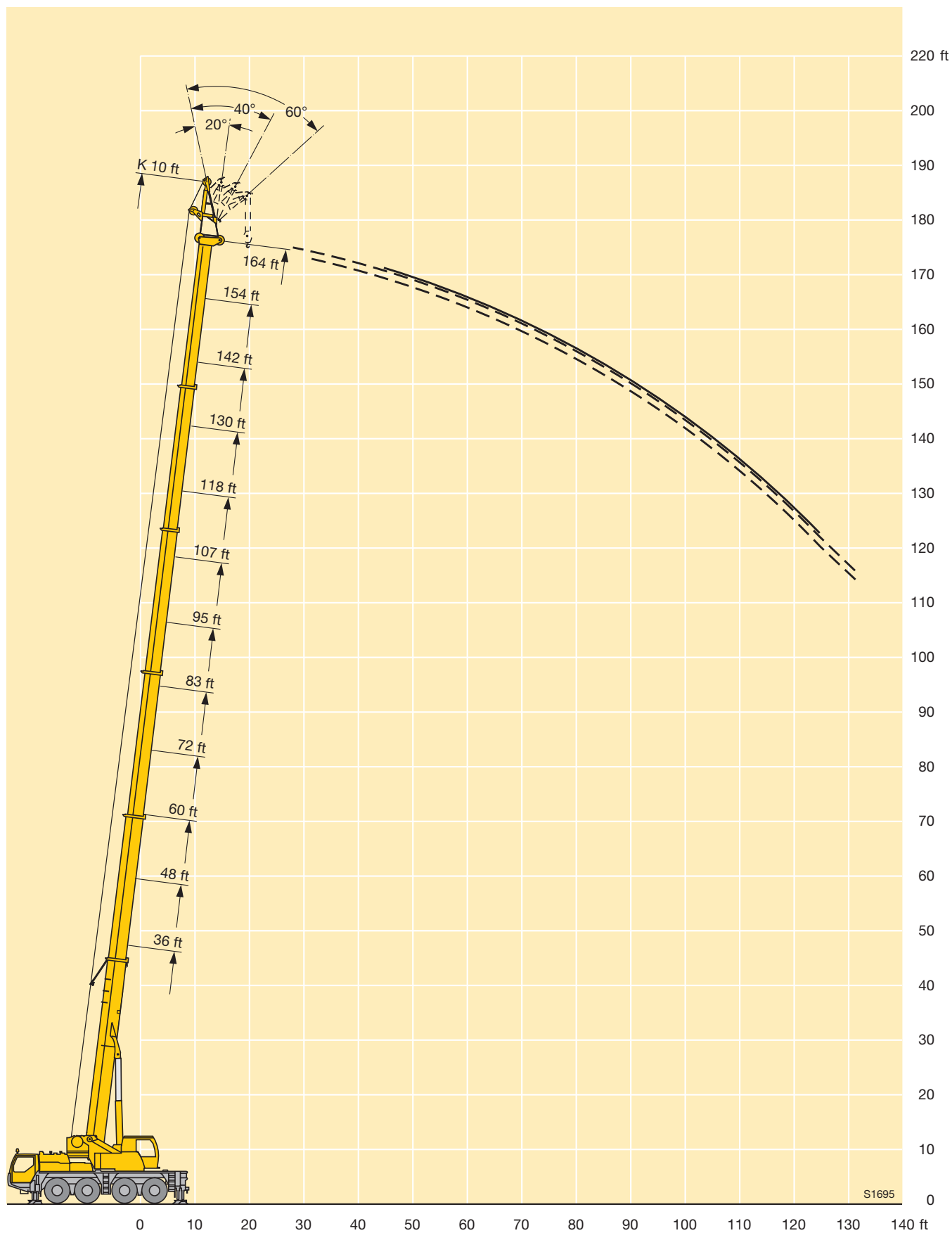



Dimensions Encombremment

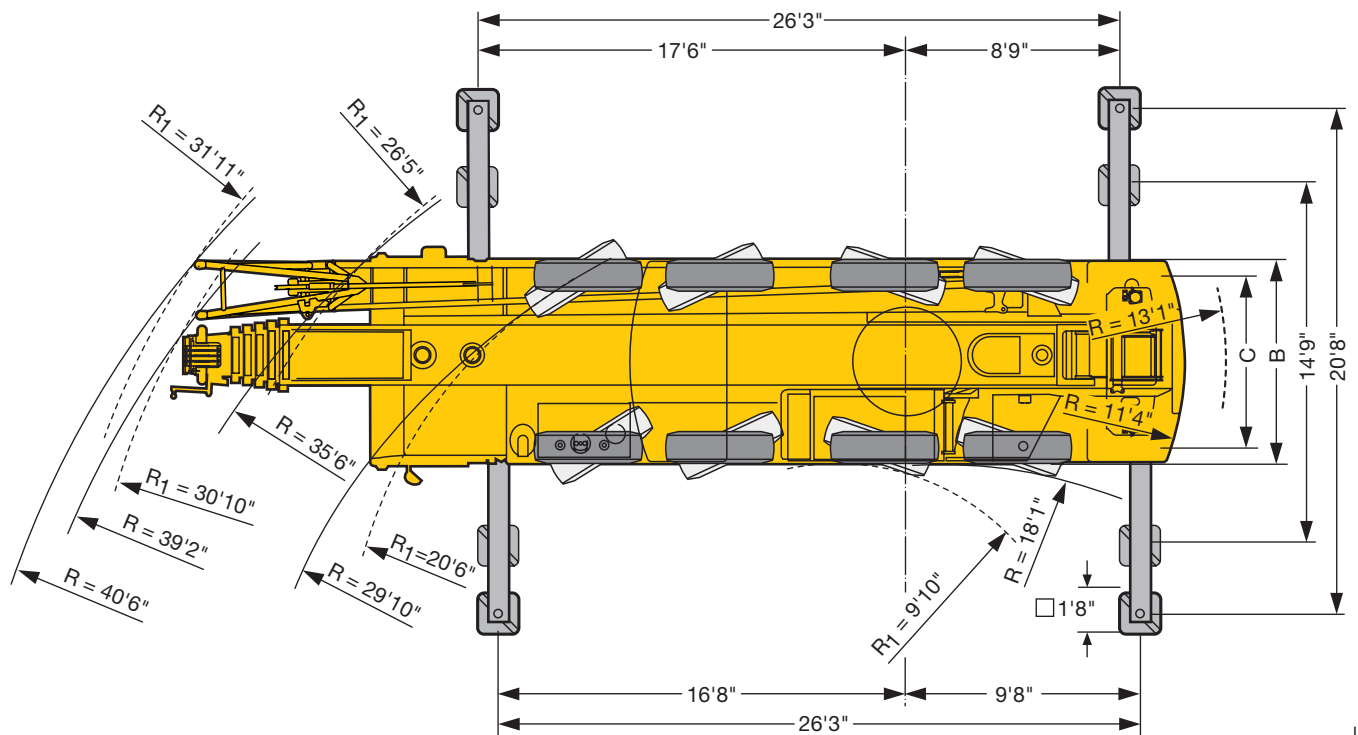
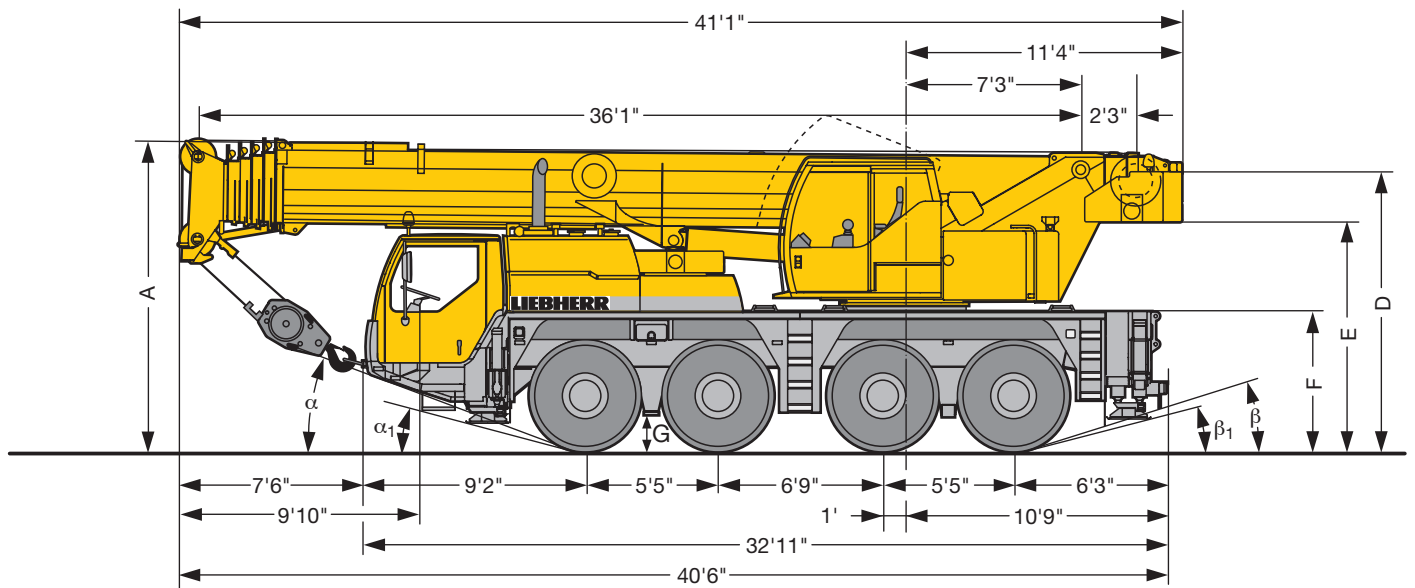

US2067

R_i = All-wheel steering / Direction toutes roues

	Dimensions / Encombremment											
	A	A 0'4" *	B	C	D	E	F	G	α	α ₁	β	β ₁
16.00 R 25	13'	12'8"	8'10"	7'4"	11'11"	9'9"	6'2"	1'6"	22°	16°	20°	16°
20.5 R 25	13'	12'8"	9'3"	7'5"	11'11"	9'9"	6'2"	1'6"	22°	16°	20°	16°

* lowered / abaissé



Weights Poids



Axle Essieu	1	2	3	4	Total weight Poids total
lbs	26400	26400	26400	26400	105600 ¹⁾

¹⁾ with 23600 lbs counterweight and folding jib / avec contrepoids 23600 lbs et fléchette pliante



Load (kips) Forces de levage (kips)	No. of sheaves Poulies	No. of lines Brins	Weight lbs Poids lbs
156.8	7	14	1102
130.8	5	11	1102
85.7	3	7	992
35.8	1	3	662
12.7	–	1	308

Working speeds Vitesses



		1	2	3	4	5	6	7	8	9	10	11	12	R 1	R 2	
16.00 R 25 20.5 R 25		3.7	4.7	6.1	7.8	9.9	12.8	16.8	21.6	27.9	35.8	45.4	50	4	5.1	37.8 %
	 	1.7	2.1	2.7	3.5	4.5	5.8	7.6	9.8	12.6	16.2	20.5	26.3	1.8	2.3	64.2 %



Drive Mécanismes	infinitely variable en continu	Rope diameter / Rope length Diamètre du câble / Longueur du câble	Max. single line pull Effort au brin maxi.
	0 – 410 ft/min single line ft/min au brin simple	0.7" / 656 ft	12600 lbs
	0 – 410 ft/min single line ft/min au brin simple	0.7" / 853 ft	12600 lbs
	0 – 1.5 min ⁻¹		
	approx. 55 seconds to reach 83° boom angle env. 55 s jusqu'à 83°		
	approx. 310 seconds for boom extension from 36 ft – 164 ft env. 310 s pour passer de 36 ft – 164 ft		



Equipment Equipment

Crane carrier

Frame	Self-manufactured, weight-optimized and torsion resistant box-type design of high-tensile structural steel.
Outriggers	4-point supporting system, hydraulically telescopic into horizontal and vertical direction. Automatic levelling of crane. Electronic inclination indicator.
Engine	6-cylinder Diesel engine, make Liebherr, type D936L A6, watercooled, 270 kW (367 HP) at 2000 rpm, max. torque 1253 lbs-ft at 1000 – 1500 rpm. Electronic engine management. Fuel tank: 92 gallons.
Transmission	ZF 12-speed gear box with automatic control system AS-TRONIC. Two-stage transfer case with lockable transfer differential.
Axles	Welded design, made of high-tensile fine grained steel. All axles steerable. Axles 3 and 4 are planetary axles with differential locks.
Suspension	All axles are mounted on hydropneumatic suspension and are lockable hydraulically.
Tyres	8 tyres, size: 16.00 R 25.
Steering	Front axles mechanically steered, with hydraulic power assistance and stand-by steering pump. Rear axles hydraulically steered. All axles steered hydrostatically from crane cab. Steering acc. to EC directive 70/311/EEC.
Brakes	Service brake: Dual circuit, all-wheel servo-air brake. Parking brake: Spring brake actuator, acting on the wheels of the 2 nd , 3 rd and 4 th axle. Sustained-action brakes: Engine brake as exhaust retarder with Liebherr additional brake system ZBS. ABV in conjunction with ASR. Brakes acc. to EG directives 71/320 EWG.
Driver's cab	Spacious, steel made, corrosion resistant cab, cataphoretic dip-primed, on resilient suspension with hydraulic shock absorbers, sound and heat absorbing internal panelling acc. to EG directive, safety glazing, operating and control instruments, comfortably equipped.
Electrical system	Modern data bus technique, 24 Volt DC, 2 batteries of 170 Ah each, lighting according to traffic regulations.

Crane superstructure

Frame	Self-manufactured, cataphoretic dip-primed weight-optimized and torsion resistant welded design of high-tensile structural steel; linked by a triple-row roller slewing ring to the carrier for continuous rotation.
Crane drive	Diesel-hydraulic with 1 axial variable displacement pump with automatic capacity control, 1 double gear pump, driven by the carrier Diesel engine, open regulated oil circuits with electrically controlled "load sensing", operation of 4 movements simultaneously.
Crane control	Electrical control of drives by self-centering joysticks, armrest-integrated control elements, Liebherr system bus (LSB).
Hoist gear	Axial piston fixed displacement motor, Liebherr hoist drum with integrated planetary gear and spring-loaded static brake. Hoist gear is driven through a controlled open oil circuit.
Luffing gear	1 differential ram with safety check valves.
Slewing gear	Axial piston fixed displacement motor, planetary gear, spring-loaded static brake. Slewing gear invertible from released to locked as a standard feature.
Crane cab	All-steel construction, entirely galvanized, powder coated, with safety glazing, operating and control instruments, comfortably equipped, cab tiltable backwards.
Safety devices	LICCON safe load indicator, test system hoist limit switch, safety valves to prevent pipe and hose ruptures.
Telescopic boom	Buckling and torsion resistant design of high-tensile structural steel, oviform boom profile, 1 base section and 5 telescopic sections. All telescopic sections hydraulically extendable independent of one another. Rapid-cycle telescoping system "Telematik". Boom length: 36 ft – 164 ft.
Counterweight	23600 lbs basic counterweight.
Electrical system	Modern data bus technique, 24 Volt DC.

Additional equipment

Swing-away jib	31 ft – 52 ft long, mountable to the telescopic boom at 0°, 20°, 40° or 60°. Hydraulic ram for operating the swing-away jib from 0° – 60° (option).
2nd hoist gear	For two-hook operation or for operation with swing-away jib if the hoist rope shall remain reeved.
Additional counterweight	8400 lbs for a total counterweight of 32000 lbs.
Tyres	8 tyres, size 20.5 R 25.
Drive 8 x 6	Additional drive of the 1 st axle.

Other items of equipment available on request.



Equipment Equipment

Châssis porteur

Cadre	Construction en caisse résistante à la torsion et optimisée en poids réalisée par Liebherr en acier de construction à grain fin très rigide.
Calage	Dispositif de calage horizontal et vertical en 4 points, entièrement déployable hydrauliquement. Nivellement automatique du calage. Indicateurs électroniques d'inclinaison.
Moteur	Diesel, 6 cylindres, marque Liebherr, type D936L A6, refroidi par eau, puissance 270 kW (367 ch) à 2000 rpm, couple max. 1253 lbs-ft à 1000 – 1500 rpm. Gestion électronique. Réservoir à carburant: 92 gallons.
Boîte de vitesse	Boîte de vitesses ZF à 12 rapports, mécanisme automatisé à commande AS-TRONIC. Boîte de transfert à 2 étages avec blocage de différentiel.
Essieux	Construction soudée en acier à haute résistance fins grains. Tous les essieux directeurs. Essieux 3 et 4 planétaires avec blocage différentiel.
Suspension	Suspension hydropneumatique sur tous les essieux. Chaque essieu peut être bloqué hydrauliquement.
Pneumatiques	8 pneus de taille: 16.00 R 25.
Direction	Direction mécanique à assistance hydraulique des essieux avants. Pompe de secours. Direction des essieux arrières enclenchable hydrauliquement. Direction hydrostatique de tous les essieux à commande depuis la cabine du grutier. Direction selon directive CE 70/311/CEE.
Freins	Freins de service: servofrein à air comprimé, à 2 circuits. Frein à main: ressort accumulé agissant sur les roues des essieux 2, 3 et 4. Freins continus: frein moteur par clapet sur échappement avec système de ralentissement Liebherr ZBS. ABV avec contrôle ASR. Freins conformes aux directives européennes 71/320 CE.
Cabine du conducteur	Cabine spacieuse en tôle d'acier, traitement anticorrosion par bain de cataphorèse, avec suspension élastique et amortisseurs hydrauliques, revêtement intérieur avec isolation phonique et thermique selon les directives européennes, glaces de sécurité, appareils de commande et de contrôle, équipement confortable.
Installation électrique	Technique moderne de transmission de données par BUS de données, courant continu 24 Volts, 2 batteries de 170 Ah chacune, éclairage conforme au code de la route.

Partie tournante

Cadre	Construction soudée résistante à la torsion et optimisée en poids réalisée par Liebherr en acier de construction à grain fin très rigide. Couronne d'orientation à rouleaux à 3 rangées permettant une rotation illimitée sert de pièce de liaison avec le châssis de la grue.
--------------	--

Entraînement de la grue	Diesel hydraulique avec 1 pompe double à débit variable et régulation de puissance automatique, 1 pompe à engrenages double, entraînés par le moteur Diesel du porteur, circuits hydrauliques ouverts avec «load sensing», régulé électriquement. 4 mouvements simultanés praticables.
Commande	Commande électrique des mécanismes par leviers de manoeuvre à centrage automatique, commandes de grue «grand confort» intégrées aux accoudoirs du siège, Liebherr système bus.
Mécanisme de levage	Moteur à cylindrée constante et à pistons axiaux. Treuil de marque Liebherr équipé d'un engrenage planétaire et d'un frein d'arrêt commandé par ressort. L'entraînement du treuil de levage s'effectue en circuit régulé et fermé.
Mécanisme de relevage	1 vérin différentiel avec soupapes de retenu.
Dispositif de rotation	Moteur à cylindrée constante à pistons axiaux, engrenage planétaire, frein d'arrêt commandé par ressort. Orientation de série commutable en circuit hydraulique ouvert ou fermé (freinage automatique ou au pied).
Cabine du grutier	Construction en tôle d'acier entièrement zinguée avec peinture par poudrage et cuisson au four, avec glaces de sécurité, appareils de commande et de contrôle, équipement confortable, cabine inclinable vers l'arrière.
Dispositif de sécurité	Contrôleur de charge «LICCON», système test limitation de la course pour le levage, soupape de sûreté contre la rupture de tubes et de tuyaux.
Flèche télescopique	Flèche télescopique en acier à haute résistance à grains fins, à profil ovale, 1 élément de base et 5 éléments télescopiques. Tous les éléments télescopiques indépendamment les uns des autres. Système de télescopage séquentiel rapide «Telematik». Longueur de flèche: 36 ft – 164 ft.
Contrepoids	Contrepoids principal de 23600 lbs.
Installation électrique	Technique moderne de transmission de données par BUS de données. Courant continu 24 Volts.

Équipement supplémentaire

Fléchette pliante	Longueur: 31 ft – 52 ft, montable sous un angle de 0°, 20°, 40° ou 60°. Vérin hydraulique pour le relevage de la fléchette pliante de 0° à 60° (en option).
2ème mécanisme de levage	Pour l'utilisation du deuxième crochet, ou bien pour une utilisation avec fléchette pliante lorsque le câble de levage principal rest mouflé.
Contrepoids supplémentaire	8400 lbs pour un contrepoids total de 32000 lbs.
Pneumatiques	8 pneus. Taille: 20.5 R 25.
Entraînement 8 x 6	Essieu 1 est entraîné additionnellement.

Autres équipements supplémentaires sur demande.