

# Potain GTMR 331 C

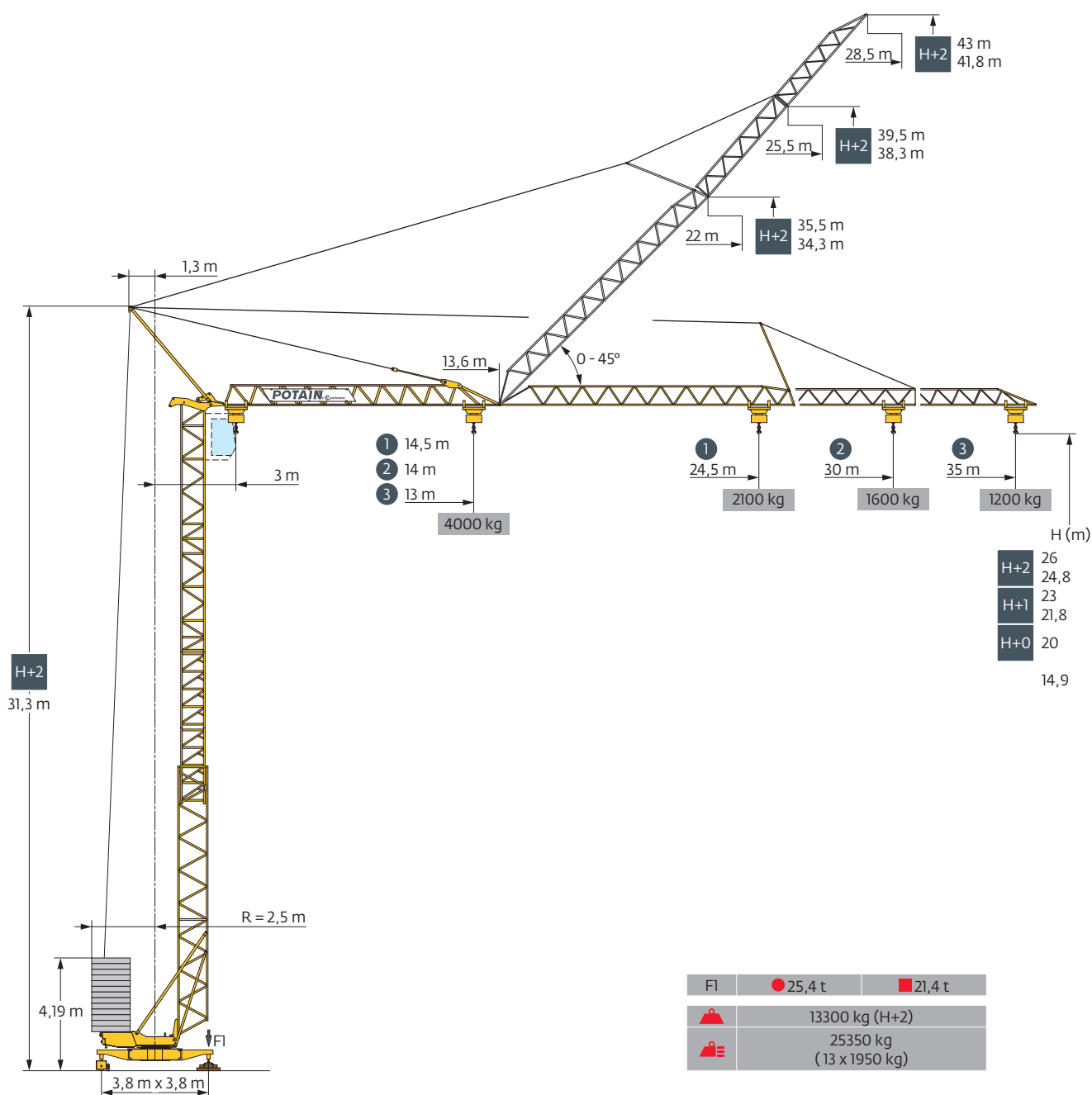

Courbes de charges / Lastkurven / Load curves / Curvas de cargas / Curve di carico  
 Curvas de carga / Кривые нагрузок

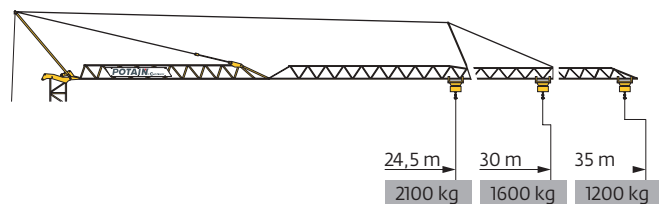



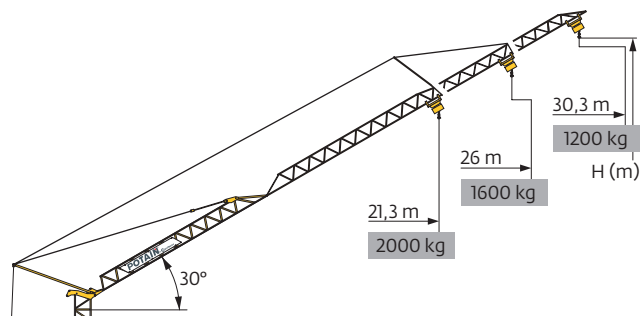



35 m	3	▶	13	14	16	18	20	22	23,2	24	26	28	30	32	34	35	m
▲▲▲	▲▲▲	▲▲▲	4000	3670	3100	2680	2350	2080	-	1870	1690	1540	1410	1290	1200	1150	kg
										-	1870	1690	1540	1410	1290	1200	kg
										2000	1920	1740	1590	1460	1340	1250	kg
30 m	3	▶	14	16	18	20	22	24	25	26	28	30	m				
▲▲▲	▲▲▲	▲▲▲	4000	3390	2930	2570	2280	2050	-	1860	1690	1550	kg				
										-	1860	1690	1550	kg			
										2000	1910	1740	1600	kg			
24,5 m	3	▶	14,5	16	18	20	22	24,5	m								
▲▲▲	▲▲▲	▲▲▲	4000	3550	3070	2700	2400	2100	kg								
									2000	kg							
									2000	kg							





35 m	3	▶	20	23	26	30,3	m
▲▲▲	▲▲▲	▲▲▲	2000	1700	1460	1200	kg
			2000	1700	1460	1200	kg
30 m	3	▶	21,7	23	26	m	
▲▲▲	▲▲▲	▲▲▲	2000	1860	1600	kg	
			2000	1860	1600	kg	
24,5 m	3	▶	21,3	m			
▲▲▲	▲▲▲	▲▲▲	2000	kg			
			2000	kg			

▲▲▲	35 m	30 m	24,5 m
H+2	42	39,5	36,8
H+1	39	36,5	33,8
H+0	36	33,5	30,8

Mécanismes / Triebwerke / Mechanisms / Mecanismos / Meccanismi  
 Mecanismos / Механизмы

400 V - 50 Hz 480 V - 60 Hz								ch - PS hp	kW	
	20 LVF 10	m/min	5	25	50	2,5	12,5	25	20	15
		kg	2000	2000	1300	4000	4000	2600		
	3 D2 V4	m/min	22 - 44						4	3
	RCV 22	tr/min U/min rpm	0 → 0,8						3	2,2
	TVD 122	m/min	25						2x2	2x1,5

 IEC 60204-32	 kVA
400 V (+10% -10%) 50 Hz 480 V (+6% -10%) 60 Hz	25 kVA

20 LVF 10

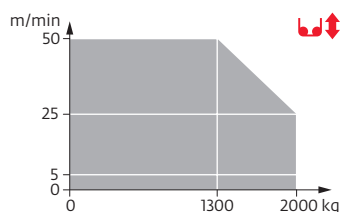

Montage / Montage / Erection / Montaje / Montaggio  
 Montagem / Монтаж

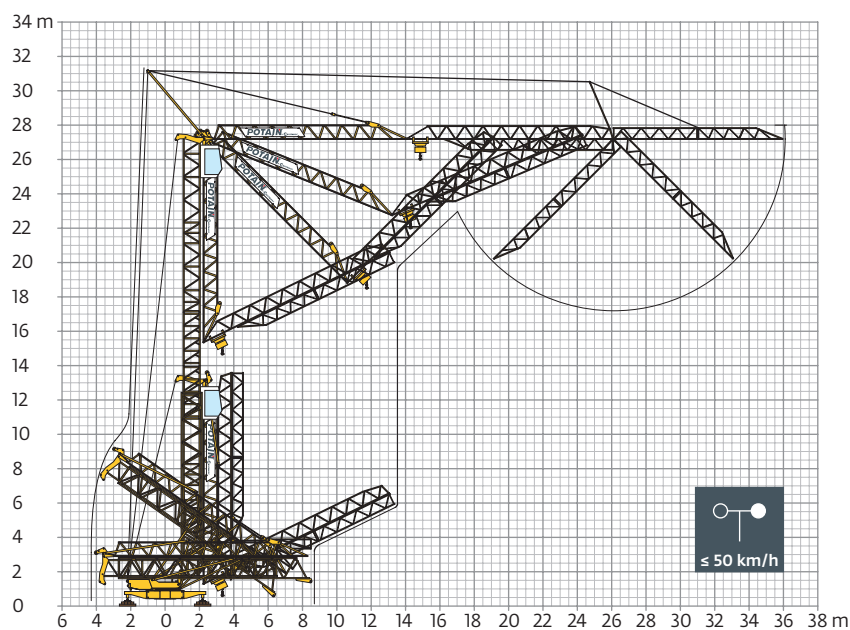

Transport / Transport / Transport / Transporte / Trasporto  
Transporte / Транспортировка

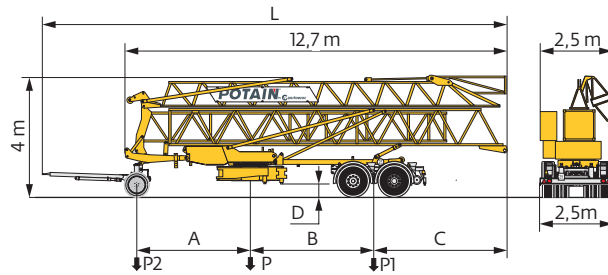

	km/h	A (m)	B (m)	C (m)	D (m)	L (m)	P (kg)	P1 (kg)	P2 (kg)
15A/25A	25	3,64	2,91	5,81	0,24	15,06	14620	10710	3910
DJ126M/S215M	25	3,57	4,16	4,56	0,29	15,38	16200	11100	5100

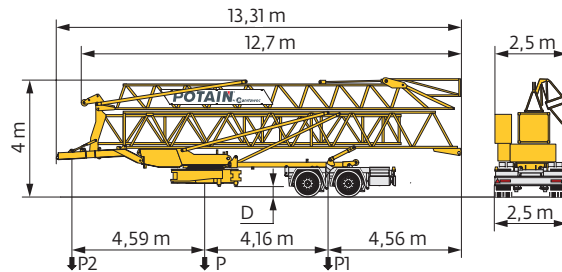

	km/h	D (m)	P (kg)	P1 (kg)	P2 (kg)
S4/S215M	25	0,20	15900	11600	4300
S5B/J215M	80	0,24	16200	11500	4700

**FR**

**DE**

**EN**

**ES**

**IT**

**PT**

**RU**

<b>R</b>	Rayon de giration	Schwenk radius	Rear slewing radius	Radio de giro	Raggio di rotazione	Raio de rotação	Задний габарит
●	Réactions en service	Reaktionskräfte in Betrieb	Reactions in service	Reacciones en servicio	Reazioni in servizio	Reacções em serviço	Реакция при работе
■	Réactions hors service	Reaktionskräfte außer Betrieb	Reactions out of service	Reacciones fuera de servicio	Reazioni fuori servizio	Reacções fora de serviço	Реакция в покое
⚖	Poids à vide, sans lest, sans trains de transport, avec flèche maxi. et hauteur standard.	Gewicht ohne Last, ohne Ballast, ohne Transportachsen, mit max. Auslager und Standardhöhe	Weight without load, without ballast, without transport axes, with max. jib and standard height	Peso en vacío, sin lastre, sin trenes de transporte con flecha y altura estándar	Peso a vuoto, senza zavorra, senza assali di trasporto, con braccio max e altezza standard.	Peso em vazio, sem lastro, sem eixos de transporte com lança máxima e altura standard.	Вес без груза, без балласта, без осей для транспортировки, с максимальной вылетом стрелы и стандартной высотой
⚖	Poids total du lest	Ballast-Gesamtgewicht	Total ballast weight	Peso total del lastre	Peso totale della zavorra	Peso total do lastro	Общий вес балласта
⬆	Levage	Heben	Hoisting	Elevación	Sollevamento	Elevação	Подъем
⬆	Distribution	Katzfahren	Trolleying	Distribución	Distribuzione	Distribuição	Перемещение по стреле
⬆	Orientation	Schwenken	Slewing	Orientación	Rotazione	Rotação	Поворот
⬆	Translation	Kranfahren	Travelling	Traslación	Traslazione	Translação	Перемещение крана
kVA	Puissance nominale	Nennleistung	Rated power	Potencia nominal	Potenza nominale	Potência nominal	Номинальная мощность

<b>!</b>	Document commercial non contractuel. Pour toute information technique se référer à la notice correspondante.	Unverbindliches Vertriebsdokument. Für technische Informationen, siehe die entsprechenden Anweisungen.	This commercial document is not legally binding. For any technical information, please refer to the corresponding instructions.	Documento comercial no contractual. Para cualquier información técnica, ver la noticia correspondiente.	Documento commerciale non vincolante, per tutte le informazioni tecniche fare riferimento al catalogo istruzioni.	Documento comercial não contratual. Para qualquer informação técnica complementar consultar as respectivas instruções.	Этот коммерческий документ не является юридически обязательным. Для получения технической информации, см. соответствующие инструкции.
----------	--	--	---	---	---	--	---

**Manitowoc**

**Manitowoc - Americas**  
Manitowoc, Wisconsin, USA  
Tel: +1 920 684 6621  
Fax: +1 920 683 6277

**Shady Grove, Pennsylvania, USA**  
Tel: +1 717 597 8121  
Fax: +1 717 597 4062

**Manitowoc - Europe, Middle East & Africa**  
Ecully, France  
Tel: +33 (0)4 72 18 20 20  
Fax: +33 (0)4 72 18 20 00

**Manitowoc - Asia & Pacific**  
Shanghai, China  
Tel: +86 21 6457 0066  
Fax: +86 21 6457 4955

Ref: GTMR 331 C 2003 48 - 8

www.manitowoc.com